

Agilent 3000 Series Oscilloscopes

User's and Service Guide



Agilent Technologies

Notices

© Agilent Technologies, Inc. 2005, 2007

No part of this manual may be reproduced in any form or by any means (including electronic storage and retrieval or translation into a foreign language) without prior agreement and written consent from Agilent Technologies, Inc. as governed by United States and international copyright laws.

Manual Part Number

D3000-97015

Edition

Third Edition, December 2007

Available in electronic format only

Agilent Technologies, Inc.
1900 Garden of the Gods Road
Colorado Springs, CO 80907 USA

Print History

D3000-97000, March 2005

D3000-97012, February 2007

D3000-97015, December 2007

Trademark Acknowledgments

Windows and MS Windows are U.S. registered trademarks of Microsoft Corporation.

MATLAB is a U.S. registered trademark of MathWorks.

Mathcad is a U.S. registered trademark of Mathsoft.

Warranty

The material contained in this document is provided “as is,” and is subject to being changed, without notice, in future editions. Further, to the maximum extent permitted by applicable law, Agilent disclaims all warranties, either express or implied, with regard to this manual and any information contained herein, including but not limited to the implied warranties of merchantability and fitness for a particular purpose. Agilent shall not be liable for errors or for incidental or consequential damages in connection with the furnishing, use, or performance of this document or of any information contained herein. Should Agilent and the user have a separate written agreement with warranty terms covering the material in this document that conflict with these terms, the warranty terms in the separate agreement shall control.

Technology Licenses

The hardware and/or software described in this document are furnished under a license and may be used or copied only in accordance with the terms of such license.

Restricted Rights Legend

U.S. Government Restricted Rights. Software and technical data rights granted to the federal government include only those rights customarily provided to end user customers. Agilent provides this customary commercial license in Software and technical data pursuant to FAR 12.211 (Technical Data) and 12.212 (Computer Software) and, for the Department of Defense, DFARS 252.227-7015 (Technical Data - Commercial Items) and DFARS 227.7202-3 (Rights in Commercial Computer Software or Computer Software Documentation).

Safety Notices

CAUTION

A **CAUTION** notice denotes a hazard. It calls attention to an operating procedure, practice, or the like that, if not correctly performed or adhered to, could result in damage to the product or loss of important data. Do not proceed beyond a **CAUTION** notice until the indicated conditions are fully understood and met.

WARNING

A **WARNING** notice denotes a hazard. It calls attention to an operating procedure, practice, or the like that, if not correctly performed or adhered to, could result in personal injury or death. Do not proceed beyond a **WARNING** notice until the indicated conditions are fully understood and met.

See also [Appendix A](#), “Safety Notices,” starting on page 147.

Agilent 3000 Series Oscilloscopes—At a Glance

The Agilent 3000 Series oscilloscopes are low-cost portable digital storage oscilloscopes (DSOs) that deliver these powerful features:

- Two-channel models and bandwidths:
 - DSO3062A: 60 MHz.
 - DSO3102A: 100 MHz.
 - DSO3152A: 150 MHz.
 - DSO3202A: 200 MHz.
- Bright 5.7 inch QVGA (320 x 240) 64K TFT color LCD display.
- Up to 1 GSa/s sample rate.
- Up to 4 kpts memory.
- Automatic voltage and time measurements (20) and cursor measurements.
- Advanced triggering (edge, pulse width, and video).
- Math function waveforms: add, subtract, multiply, FFT.
- USB ports (1 host with rear panel module, 1 device) for easy printing, saving, and sharing of waveforms, setups, screen BMP files, and CSV data files.
- Internal storage for 10 waveforms and 10 setups.
- Special digital filter and waveform recorder.
- Built-in 5-digit hardware frequency counter.
- Multi-language (11) user interface menus.

In This Book

This guide shows how to use the Agilent 3000 Series oscilloscopes.

1 Getting Started

Describes the basic steps to take when first using the oscilloscope.

2 Displaying Data

Describes how to use the horizontal and vertical controls, channel settings, math waveforms, reference waveforms, and display settings.

3 Capturing Data

Describes acquisition and sampling modes and how to set up triggers.

4 Making Measurements

Describes voltage, time, and cursor measurements.

5 Saving, Recalling, and Printing Data

Describes how to save, recall, and print data.

6 Oscilloscope Utility Settings

Describes other oscilloscope settings found in the **Utility** menu.

7 Specifications and Characteristics

Describes the 3000 Series oscilloscopes' specifications and characteristics.

8 Service

Describes oscilloscope maintenance, performance testing, and what to do if your oscilloscope requires service.

Contents

	Agilent 3000 Series Oscilloscopes—At a Glance	3
	In This Book	4
	Figures	13
	Tables	15
1	Getting Started	17
	Step 1. Inspect the package contents	18
	Step 2. Turn on the oscilloscope	21
	Step 3. Load the default oscilloscope setup	22
	Step 4. Input a waveform	23
		23
	Step 5. Become familiar with the Front Panel Controls	24
	Using the Oscilloscope Menus	26
	Step 6. Become familiar with the oscilloscope display	28
	Step 7. Use Auto-Scale	29
	Step 8. Compensate probes	31
	Low Frequency Compensation	31
	High Frequency Compensation	32
	Step 9. Use the Run Control buttons	33

2	Displaying Data	35
	Using the Horizontal Controls	36
	To adjust the horizontal scale	38
	To adjust the horizontal position	39
	To display the delayed sweep time base	39
	To change the horizontal time base (Y-T or X-Y)	40
	To reset the trigger offset	42
	To specify a trigger holdoff	42
	To view the sample rate	43
	Using the Vertical Controls	44
	To turn waveforms on or off (channel, math, or reference)	45
	To adjust the vertical scale	45
	To adjust the vertical position	46
	To specify channel coupling	46
	To specify a bandwidth limit	48
	To specify the probe attenuation	50
	To use a digital filter	51
	To invert a waveform	51
	Using Math Function Waveforms	53
	To add, subtract, or multiply waveforms	54
	To display the frequency domain using FFT	54
	Using a Reference Waveform	57
	To save a reference waveform	57
	To position, scale, and invert a reference waveform	57

Changing the Display Settings	58
To display waveforms as vectors or dots	58
To change the grid	58
To use waveform persistence	59
To clear the display	59
To adjust the display brightness	59
To change the menu display time	59
To invert screen colors	60
3 Capturing Data	61
Overview of Sampling	62
Sampling Theory	62
Aliasing	62
Oscilloscope Bandwidth and Sample Rate	63
Oscilloscope Rise Time	65
Oscilloscope Bandwidth Required	66
Memory Depth and Sample Rate	67
Choosing the Sampling Mode	68
To select the real-time sampling mode	69
To select the equivalent-time sampling mode	70
Choosing the Acquisition Mode	72
To select the Normal acquisition mode	72
To select the Average acquisition mode	72
To select the Peak Detect acquisition mode	74
Adjusting the Trigger Level	76
To adjust the trigger level	76
To force a trigger	77
Choosing the Trigger Mode	78
To set up edge triggers	78
To set up pulse width triggers	79
To set up video triggers	80

Contents

Setting Other Trigger Parameters	82
To set the trigger sweep	82
To set the trigger coupling	82
Using the External Trigger Input	83
Recording/Playing-back Waveforms	83
To record waveforms	83
To play-back waveforms	84
To store recorded waveforms	86
4 Making Measurements	87
Displaying Automatic Measurements	88
To display an automatic measurement	88
To clear automatic measurements from the display	89
To display or hide all automatic measurements	89
Voltage Measurements	90
Vpp (Peak-to-Peak Voltage)	90
Vmax (Maximum Voltage)	91
Vmin (Minimum Voltage)	91
Vavg (Average Voltage)	91
Vamp (Amplitude Voltage = $V_{top} - V_{base}$)	91
Vtop (Top Voltage)	91
Vbase (Base Voltage)	91
Vrms (Root-Mean-Square Voltage)	92
Overshoot	92
Preshoot	92

Time Measurements	93
Frequency	93
Period	93
Rise Time	94
Fall Time	94
Positive Pulse Width	95
Negative Pulse Width	95
Positive Duty Cycle	95
Negative Duty Cycle	95
Delay Between Rising Edges	96
Delay Between Falling Edges	96
Counter (Frequency)	96
Making Cursor Measurements	98
To use manually adjustable cursors	98
To use tracking cross-hair cursors	99
To display cursors for automatic measurements	100
5 Saving, Recalling, and Printing Data	101
Saving and Recalling Waveforms and Setups	102
To save and load waveforms	102
To save and load oscilloscope setups	103
Saving to and Recalling from a USB Mass Storage Device	104
To save/load waveforms to/from a USB device	104
To save/load oscilloscope setups to/from a USB device	105
To save screens to BMP format files (on a USB device)	105
To save data to CSV format files (on a USB device)	106
To save a file to a USB device	106
To load a file from a USB device	108
Printing the Display to a USB Printer	109
Supported Printers	110

- 6 Oscilloscope Utility Settings 111**
 - Performing Mask Tests 112
 - To enable/disable mask tests 112
 - To select the source channel for mask tests 112
 - To run/stop a mask test 112
 - To turn on/off the mask test message display 113
 - To set the mask test output condition 113
 - To stop a mask test on the output condition 113
 - To set up masks 114
 - Setting IO Parameters 115
 - Setting the Menu Language 115
 - Turning Sound ON or OFF 116
 - Displaying System Information 116
 - Performing Self-Tests 117
 - To perform screen tests 117
 - To perform key tests 117
 - Running Self-Calibration 118
- 7 Specifications and Characteristics 119**
 - Specifications 120
 - Characteristics 121
- 8 Service 127**
 - Testing Performance 128
 - Before Testing Performance 129
 - Vertical Performance Verification 130
 - DC Gain Accuracy Test 130
 - Analog Bandwidth - Maximum Frequency Check 135
 - Performance Test Record 144

Returning the Oscilloscope to Agilent for Service	146
Contacting Agilent	146
A Safety Notices	147
Warnings	147
To clean the instrument	148
Safety Symbols	149
Index	151

Contents

Figures

Figure 1. Package Contents	19
Figure 2. Save/Recall Button	22
Figure 3. Front Panel	24
Figure 4. Menu Buttons	26
Figure 5. Oscilloscope Display	28
Figure 6. Auto-Scale Button	29
Figure 7. Low Frequency Probe Compensation	31
Figure 8. High Frequency Probe Compensation	32
Figure 9. Run Control Buttons	33
Figure 10. Horizontal Controls	36
Figure 11. Status Bar, Trigger Position, and Horizontal Scale Indicators	37
Figure 12. Delayed Sweep Time Base Window	40
Figure 13. X-Y Display Format Showing In-Phase Waveforms	41
Figure 14. Trigger Holdoff	42
Figure 15. Vertical Controls	44
Figure 16. DC Coupling Control	47
Figure 17. AC Coupling Control	47
Figure 18. GND Coupling Control	48
Figure 19. BW Limit Control ON	49
Figure 20. BW Limit Control OFF	49
Figure 21. Probe Attenuation Set to 1000:1	50
Figure 22. Waveform Before Inversion	52
Figure 23. Waveform After Inversion	52
Figure 24. Math Scale Setting Value	53
Figure 25. FFT Waveform	56
Figure 26. Display Button	58
Figure 27. Aliasing	63
Figure 28. Theoretical Brick-Wall Frequency Response	64

Figures

Figure 29. Sample Rate and Oscilloscope Bandwidth	65
Figure 30. Acquire Button	68
Figure 31. Real-Time Sampling Mode	69
Figure 32. Equivalent-Time (Repetitive) Sampling Mode	70
Figure 33. Noisy Waveform Without Averaging	73
Figure 34. Noisy Waveform With Averaging	73
Figure 35. Peak Detect Waveform	74
Figure 36. Trigger Controls	76
Figure 37. Line Synchronization	81
Figure 38. Field Synchronization	81
Figure 39. Measure Button	88
Figure 40. Voltage Measurement Points	90
Figure 41. Period and Frequency Measurements	94
Figure 42. Rise Time and Fall Time Measurements	94
Figure 43. Positive Pulse Width and Negative Pulse Width Measurements	95
Figure 44. Delay Measurements	96
Figure 45. Cursors Button	98
Figure 46. Save/Recall Button	102
Figure 47. USB Module on Rear Panel	104
Figure 48. USB Device Save Menu	106
Figure 49. USB Device Load Menu	108
Figure 50. Utility Button	111
Figure 51. Calibration Screen	118
Figure 52. Default Setup Menu Item	131
Figure 53. Averages Menu Item	132
Figure 54. Connecting Equipment for DC Gain Accuracy Test	133
Figure 55. Vavg Menu Item	134
Figure 56. Connecting Equipment for Maximum Frequency Check Test	137
Figure 57. Default Setup Menu Item	138
Figure 58. Channel 1 Vertical Scale Setting	139
Figure 59. Channel 1 Horizontal Scale Setting	139
Figure 60. Averages Menu Item	140
Figure 61. Signal Generator Waveform	141

Tables

Table 1. Power Cords	20
Table 2. Auto-Scale Default Settings	30
Table 3. FFT Window Characteristics	55
Table 4. Specifications	120
Table 5. Acquisition System Characteristics	121
Table 6. Vertical System Characteristics	121
Table 7. Horizontal System Characteristics	122
Table 8. Trigger System Characteristics	122
Table 9. Display System Characteristics	124
Table 10. Measurement Features	124
Table 11. General Characteristics	124
Table 12. Power Requirements	125
Table 13. Environmental Characteristics	125
Table 14. Other	125
Table 15. Equipment Required for Performance Verification Testing	129
Table 16. DC Gain Accuracy Specification	130
Table 17. Equipment Required for DC Gain Accuracy Test	130
Table 18. DC Gain Accuracy Specification	136
Table 19. Equipment Required for Performance Verification Testing	136
Table 20. Oscilloscope Models and Signal Generator Frequency	142
Table 21. DC Gain Test	144
Table 22. Analog Bandwidth - Maximum Frequency Check	145

Tables

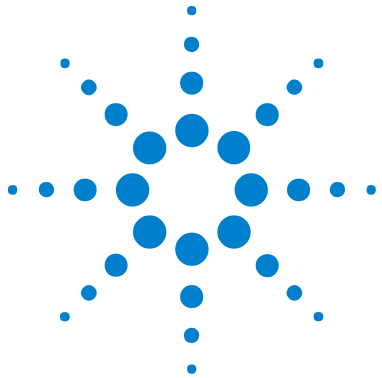

1 Getting Started

- Step 1. Inspect the package contents 18
- Step 2. Turn on the oscilloscope 21
- Step 3. Load the default oscilloscope setup 22
- Step 4. Input a waveform 23
- Step 5. Become familiar with the Front Panel Controls 24
- Step 6. Become familiar with the oscilloscope display 28
- Step 7. Use Auto-Scale 29
- Step 8. Compensate probes 31
- Step 9. Use the Run Control buttons 33

This chapter describes the basic steps to take when first using the oscilloscope.



Step 1. Inspect the package contents

1 Inspect the shipping container for damage.

Keep a damaged shipping container or cushioning material until you have inspected the contents of the shipment for completeness and have checked the oscilloscope mechanically and electrically.

2 Verify that you received the following items in the oscilloscope packaging:

- Oscilloscope.
- Power cord (see [Table 1](#)).
- (2) N2862A 10:1 10 M Ω passive probes (60 MHz and 100 MHz models).
- (2) N2863A 10:1 10 M Ω passive probes (100 MHz and 200 MHz models).
- CD-ROM containing user documentation.

If anything is missing, contact your nearest Agilent Technologies sales office.

3 Inspect the oscilloscope.

- If there is mechanical damage or a defect, or if the oscilloscope does not operate properly or does not pass performance tests, notify your Agilent Technologies sales office.
- If the shipping container is damaged, or the cushioning materials show signs of stress, notify the carrier; then, contact your nearest Agilent Technologies sales office.

Keep the shipping materials for the carrier's inspection.

The Agilent Technologies sales office will arrange for repair or replacement at Agilent's option without waiting for claim settlement.

See Also [“Contacting Agilent”](#) on page 146.

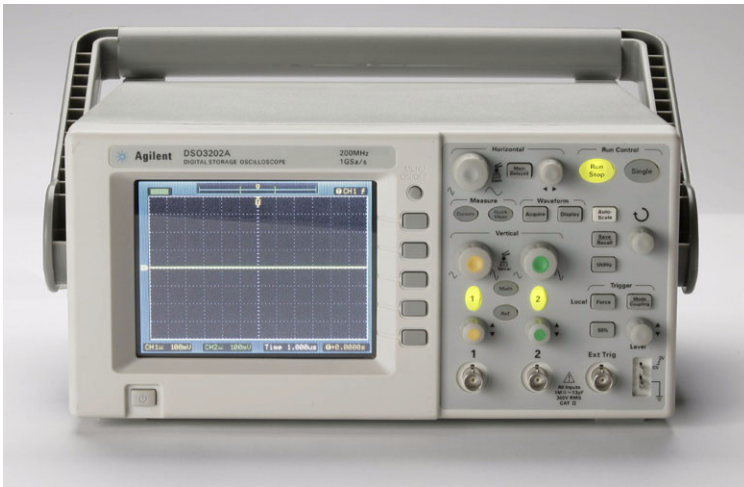

CD-ROM Manuals

Figure 1 Package Contents

Table 1 Power Cords

Option	Country	Cable Part No.
Option 900	United Kingdom, Cyprus, Nigeria, Zimbabwe, Singapore	8120-1703
Option 901	Australia, New Zealand	8120-0696
Option 902	East and West Europe, Saudi Arabia, So. Africa, India (unpolarized in many nations)	8120-1692
Option 903	United States, Canada, Mexico, Philippines, Taiwan	8120-1521
Option 906	Switzerland	8120-2296
Option 912	Denmark	8120-2957
Option 917	Republic of South Africa, India	8120-4600
Option 918	Japan	8120-4754
Option 919	Israel	8120-6799
Option 920	Argentina	8120-6871
Option 921	Chile	8120-6979
Option 922	China	8120-8377
Option 927	Brazil, Thailand	8120-8871

Step 2. Turn on the oscilloscope

The next few steps (turning on the oscilloscope, loading the default setup, and inputting a waveform) will provide a quick functional check to verify the oscilloscope is operating correctly.

- 1 Connect the power cord to a power source.

Use only power cords designed for your oscilloscope.

Use a power source that delivers the required power (see [Table 12](#) on page 125).

WARNING

To avoid electric shock, be sure the oscilloscope is properly grounded.

- 2 Turn on the oscilloscope.

Wait until the display shows that all self-tests passed.

Step 3. Load the default oscilloscope setup

You can recall the factory default setup any time you want to return the oscilloscope to its original setup.

- 1 Press the **Save/Recall** button.
- 2 In the Save/Recall menu, press the **Storage** menu button until “Setups” is selected.
- 3 Press the **Default Setup** menu button.

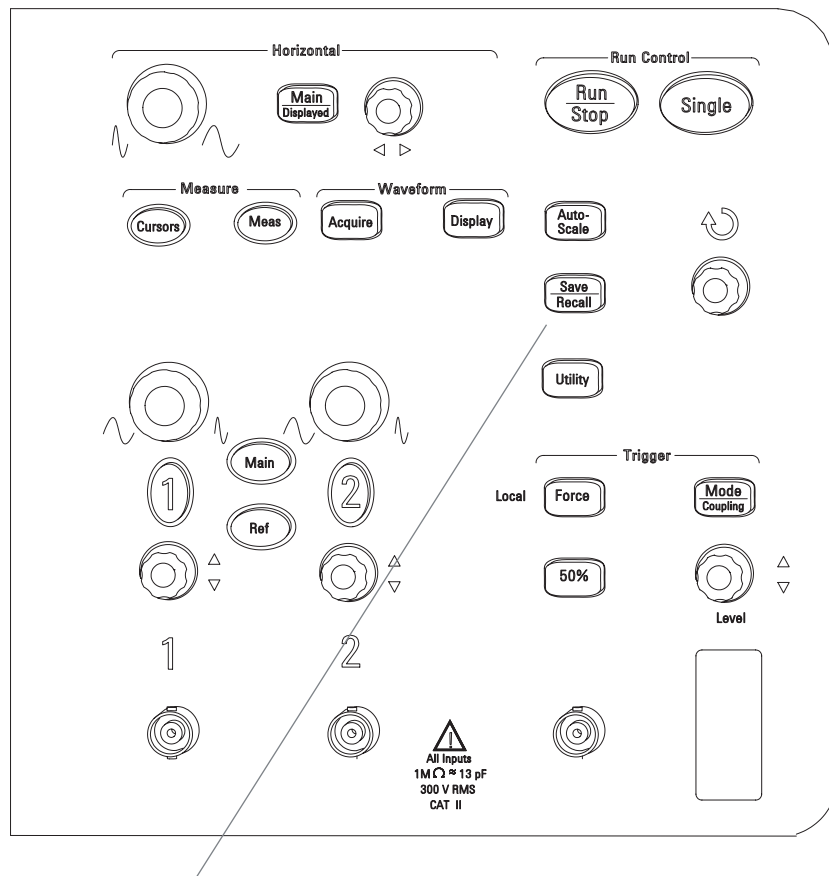

Figure 2 Save/Recall Button

Step 4. Input a waveform

- 1 Input a waveform to a channel of the oscilloscope.

Use one of the supplied passive probes to input the probe compensation signal from the front panel of the oscilloscope.

CAUTION

To avoid damage to the oscilloscope, make sure that the input voltage at the BNC connector does not exceed the maximum voltage (300 Vrms maximum).



Step 5. Become familiar with the Front Panel Controls

Before using the oscilloscope, familiarize yourself with the front panel controls.

The front panel has knobs and buttons. Knobs are used most often to make adjustments. Buttons are used for run controls and to change other oscilloscope settings via menus.

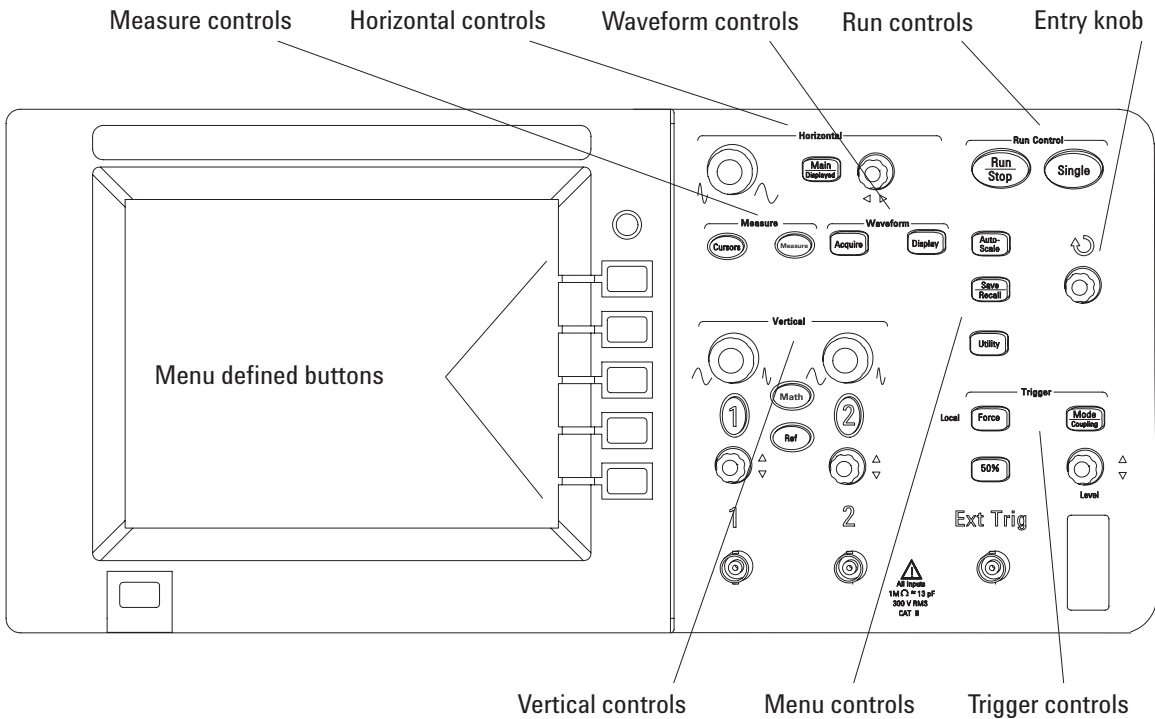

Figure 3 Front Panel

The definitions of the buttons and the knobs are as follows:

Measure controls	<u>Cursors</u> and <u>Measure</u> menu buttons.
Waveform controls	<u>Acquire</u> and <u>Display</u> menu buttons.
Menu controls	<u>Save/Recall</u> and <u>Utility</u> menu buttons.
Vertical controls	Vertical position knobs, vertical scale knobs, channel (<u>1</u> , <u>2</u>) <u>Math</u> , and <u>Ref</u> menu buttons.
Horizontal controls	Position knob, <u>Main/Delayed</u> menu button, and scale knob.
Trigger controls	Trigger <u>Level</u> knob, <u>50%</u> , <u>Mode/Coupling</u> , and <u>Force</u> buttons.
Run controls	<u>Run/Stop</u> , <u>Single</u> , and <u>Auto-Scale</u> buttons.
Menu defined buttons	Five gray buttons from top to bottom on the right-hand side of the screen, which select the adjacent menu items in the currently displayed menu.
<u>Entry knob</u>	For the adjustment defined controls.

Using the Oscilloscope Menus

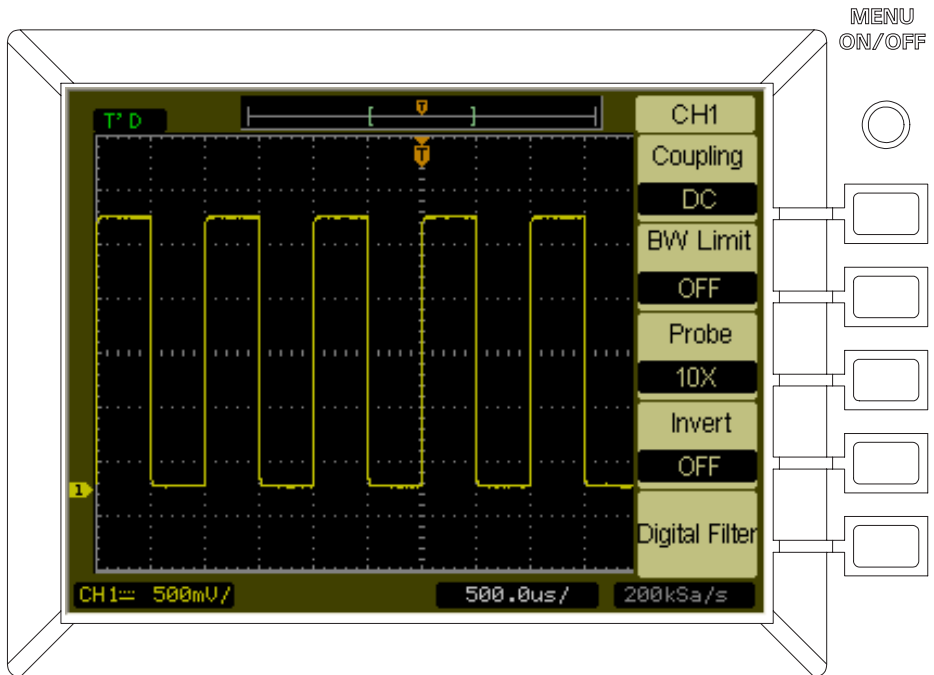



Figure 4 Menu Buttons

When one of the oscilloscope front panel buttons turns on a menu, you can use the five menu buttons to select items from the menu.

Some common menu item selections are:

- 
– accesses the next page of items in the menu.
- 
– accesses the previous page of items in the menu.

The **Menu On/Off** button turns off the menu or turns on the last accessed menu again. The **Menu Display** item in the Display menu lets you select the amount of time menus are displayed (see [“To change the menu display time”](#) on page 59).

Step 6. Become familiar with the oscilloscope display

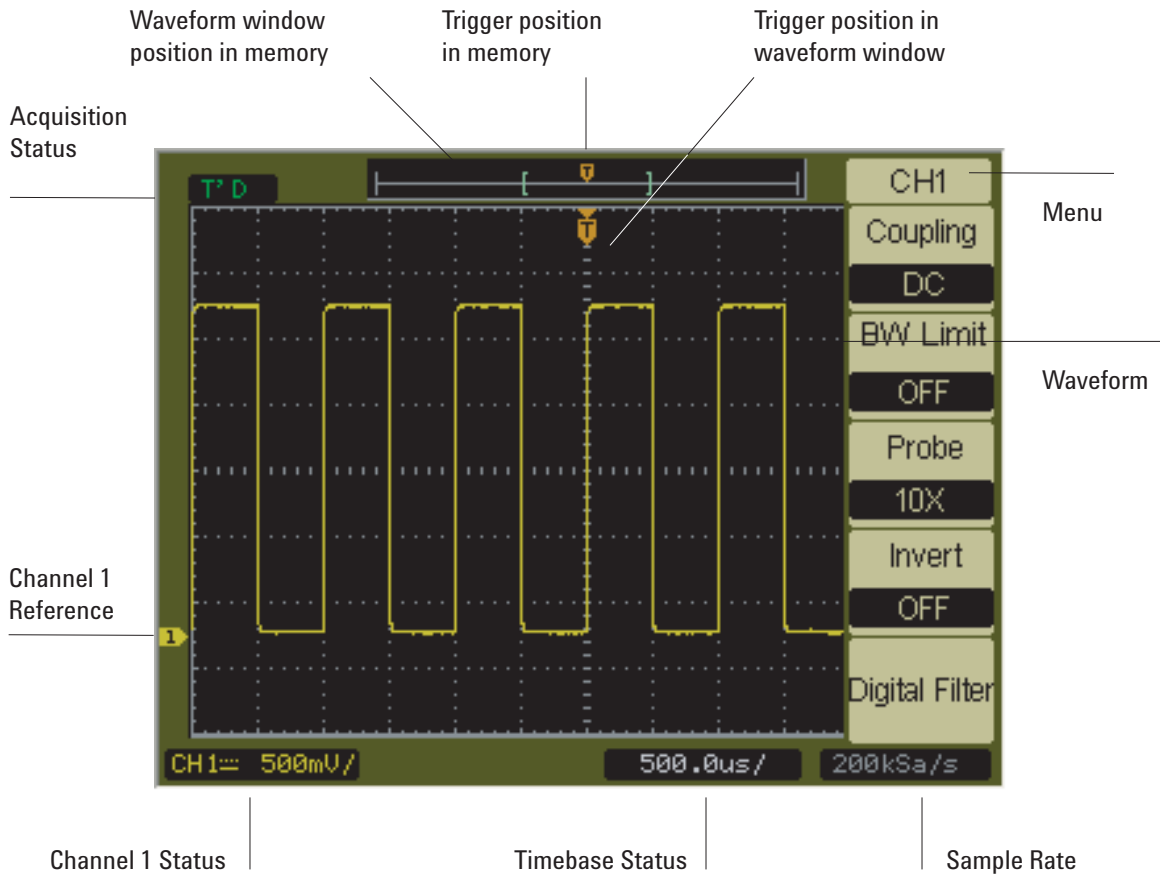

Figure 5 Oscilloscope Display

Step 7. Use Auto-Scale

The oscilloscope has an auto-scale feature that automatically sets the oscilloscope controls for the input waveforms present.

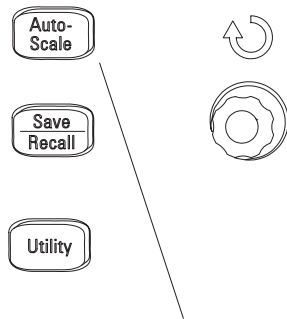

Figure 6 Auto-Scale Button

Auto-scale requires waveforms with a frequency greater than or equal to 50 Hz and a duty cycle greater than 1%.

1 Press **Auto-Scale**.

The oscilloscope turns on all channels that have waveforms applied and sets the vertical and horizontal scales appropriately. It also selects a time base range based on the trigger source. The trigger source selected is the lowest numbered channel that has a waveform applied.

The oscilloscope is configured to the following default control settings:

Table 2 Auto-Scale Default Settings

Menu	Setting
Horizontal time base	Y-T
Sampling mode	Real Time
Acquire mode	Normal
Vertical coupling	Adjusted to AC or DC according to the waveform.
Vertical "V/div"	Adjusted
Bandwidth limit	OFF
Waveform invert	OFF
Horizontal position	Center
Horizontal "time/div"	Adjusted
Trigger type	Edge
Trigger source	Measure the channel with input waveform automatically.
Trigger coupling	DC
Trigger level	Midpoint setting
Trigger sweep	Auto

Step 8. Compensate probes

Compensate probes to match your probe to the input channel. You should compensate a probe whenever you attach it for the first time to any input channel.

Low Frequency Compensation

For the supplied passive probes:

- 1 Set the Probe menu attenuation to 10X. If you use the probe hooktip, ensure a proper connection by firmly inserting the tip onto the probe.
- 2 Attach the probe tip to the probe compensation connector and the ground lead to the probe compensator ground connector.
- 3 Press the **Auto-Scale** front panel button.

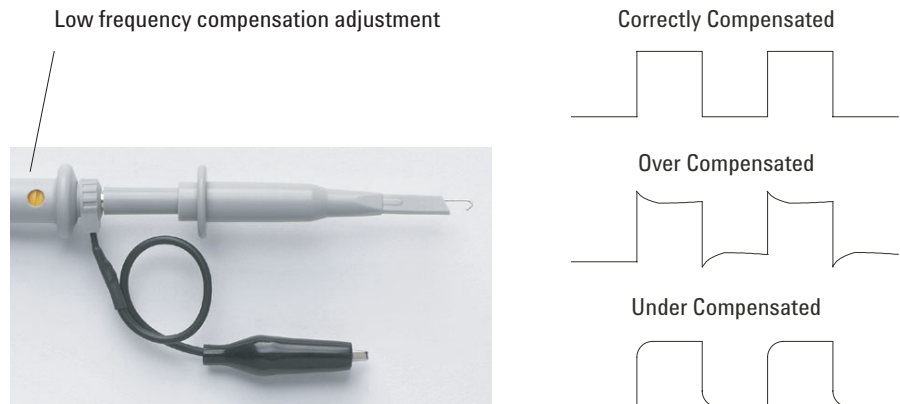

Figure 7 Low Frequency Probe Compensation

- 4 If waveform does not appear like the Correctly Compensated waveform shown in [Figure 7](#), then use a nonmetallic tool to adjust the low frequency compensation adjustment on the probe for the flattest square wave possible.

High Frequency Compensation

For the supplied passive probes:

- 1 Using the BNC adapter, connect the probe to a square wave generator.
- 2 Set the square wave generator to a frequency of 1 MHz, an amplitude of 3 Vp-p, and an output termination of 50Ω.
- 3 Press the **Auto-Scale** front panel button.

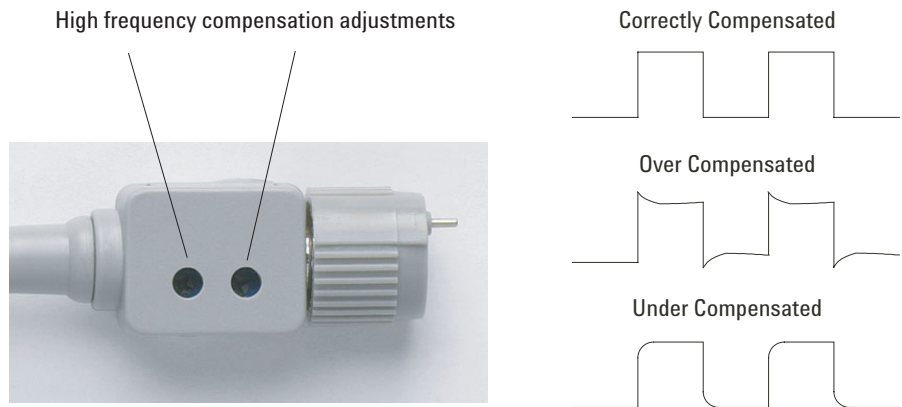

Figure 8 High Frequency Probe Compensation

- 4 If waveform does not appear like the Correctly Compensated waveform shown in [Figure 8](#), then use a nonmetallic tool to adjust the 2 high frequency compensation adjustments on the probe for the flattest square wave possible.

Step 9. Use the Run Control buttons

There are two buttons for starting and stopping the oscilloscope's acquisition system: **Run/Stop** and **Single**.

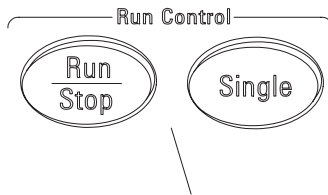

Figure 9 Run Control Buttons

- When the **Run/Stop** button is green, the oscilloscope is acquiring data. To stop acquiring data, press **Run/Stop**. When stopped, the last acquired waveform is displayed.
- When the **Run/Stop** button is red, data acquisition is stopped. To start acquiring data, press **Run/Stop**.
- To capture and display a single acquisition (whether the oscilloscope is running or stopped), press **Single**. After capturing and displaying a single acquisition, the **Run/Stop** button is red.



2 Displaying Data

Using the Horizontal Controls	36
Using the Vertical Controls	44
Using Math Function Waveforms	53
Using a Reference Waveform	57
Changing the Display Settings	58

This chapter describes how to use the horizontal and vertical controls, channel settings, math waveforms, reference waveforms, and display settings.



Using the Horizontal Controls

The horizontal controls consist of:

- The horizontal scale knob – changes the oscilloscope’s time per division setting using the center of the screen as a reference.
- The horizontal position knob – changes the position of the trigger point relative to the center of the screen.
- The **Main/Delayed** button – displays the Main/Delayed menu which lets you display the delayed time base, change the time base mode, reset the trigger offset, adjust the trigger holdoff, and reset the trigger holdoff.

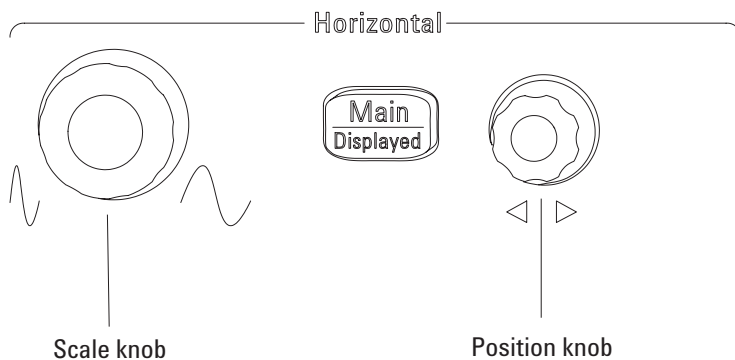

Figure 10 Horizontal Controls

Figure 11 shows the screen icon descriptions and control indicators.

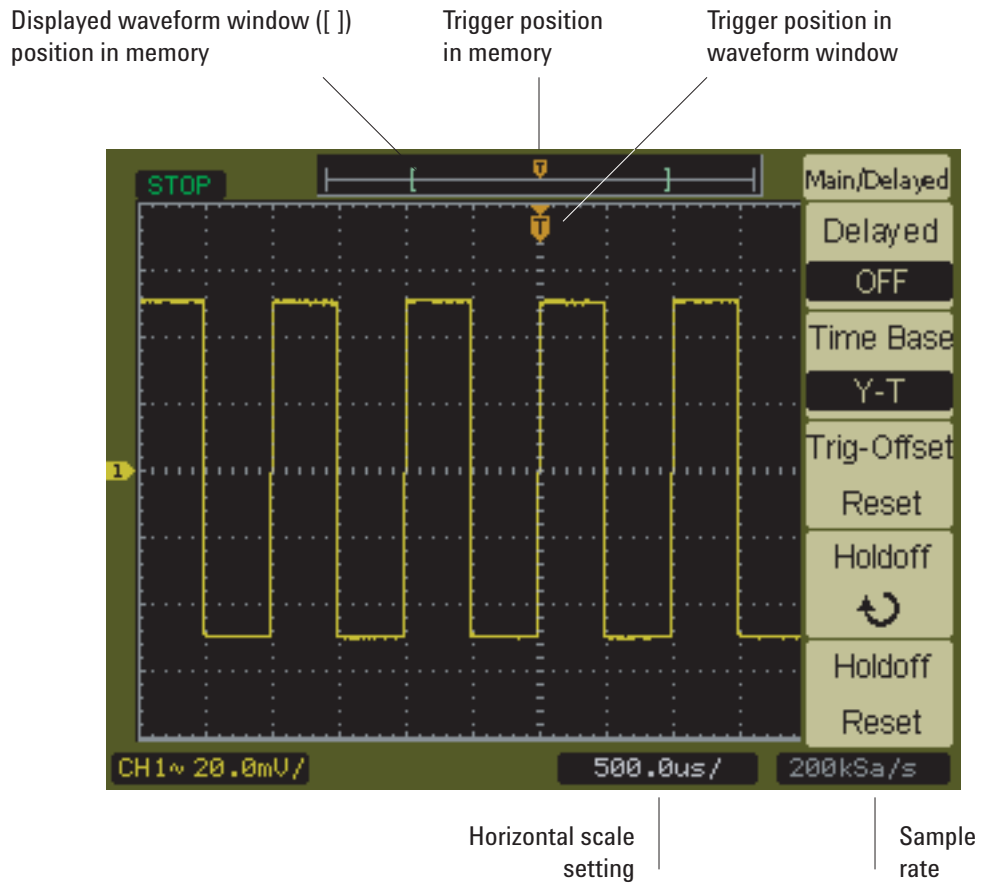

Figure 11 Status Bar, Trigger Position, and Horizontal Scale Indicators

To adjust the horizontal scale

- Turn the horizontal scale knob to change the horizontal time per division (time/div) setting (and the oscilloscope's sample rate – see “Memory Depth and Sample Rate” on page 67).

The time/div setting changes in a 1-2-5 step sequence.

The time/div setting is also known as the *sweep speed*.

When the time/div is set to 50 ms/div or slower, the oscilloscope enters Slow Scan mode (see “Slow Scan Mode” below).

When the horizontal scale is set to 20 ns or faster, the oscilloscope uses sine(x)/x interpolation to expand the horizontal time base.

- Push the horizontal scale knob to toggle between vernier (fine scale) adjustment and normal adjustment.

With vernier adjustment, the time/div setting changes in small steps between the normal (coarse scale) settings.

The time/div setting is displayed in the status bar at the bottom of the screen. Because all channels are displayed in the same time base, the oscilloscope displays one time/div setting for all channels.

Slow Scan Mode

When the horizontal scale is set to 50 ms/div or slower, the oscilloscope enters Slow Scan mode.

In the Slow Scan mode, peak detect acquisition is used so that no data is missed (even though the Acquire menu may show a different acquisition mode setting). The oscilloscope acquires sufficient data for the pre-trigger part of the display, then waits for the trigger. When the trigger occurs, the oscilloscope continues to capture data for the post-trigger part of the display.

When using the Slow Scan mode to view low frequency signals, the channel coupling should be set to “DC”.

The Slow Scan mode lets you see dynamic changes (like the adjustment of a potentiometer) on low frequency waveforms. For example, Slow Scan mode is often used in applications like transducer monitoring and power supply testing.

To adjust the horizontal position

- Turn the horizontal position knob to change the position of the trigger point relative to the center of the screen.

The position knob adjusts the horizontal position of all channels, math functions, and reference waveforms.

There is also a menu item to return the trigger position to the center of the screen (see [“To reset the trigger offset”](#) on page 42).

To display the delayed sweep time base

The delayed sweep time base magnifies a portion of the original waveform display (now on the top half of the screen) and displays it in a zoomed time base on the bottom half of the screen.

1 Press **Main/Delayed**.

2 In the Main/Delayed menu, select **Delayed** to toggle the delayed sweep time base “ON” or “OFF”.

3 When the delayed sweep time base is “ON”:

- The top half of the display shows the original waveform and the portion being magnified.
- The horizontal scale knob changes the magnification (widens or narrows the area of magnification).
- The horizontal position knob moves the area of magnification forward and backward on the original waveform.
- The bottom half of the display shows the magnified data in the delayed sweep time base.

NOTE

The delayed sweep time base setting cannot be set slower than the original waveform’s time base setting.

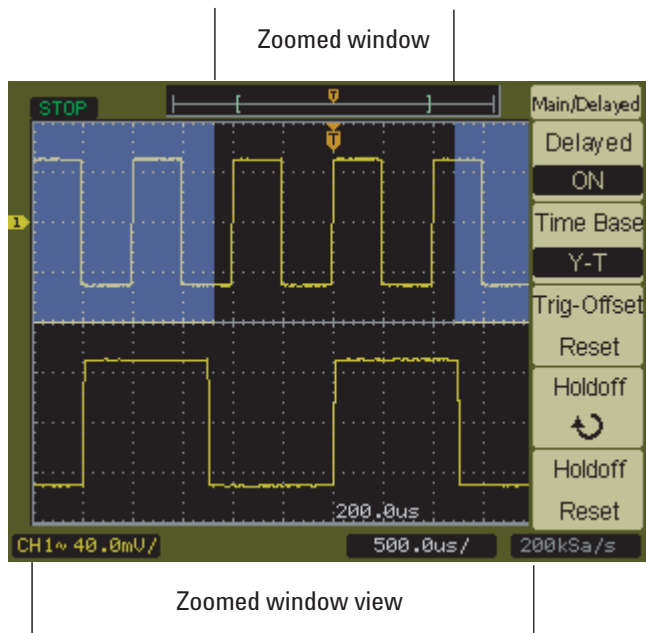

Figure 12 Delayed Sweep Time Base Window

To change the horizontal time base (Y-T or X-Y)

- 1 Press **Main/Delayed**.
- 2 In the Main/Delayed menu, press **Time Base** to select between:
 - Y-T – Amplitude vs. time. This is the typical horizontal time base setting.
 - X-Y – Channel 2 (X-axis) vs. Channel 1 (Y-axis), see “X-Y Format” on page 41.

X-Y Format

This format compares the voltage level of two waveforms point by point. It is useful for studying phase relationships between two waveforms. This format only applies to channels 1 and 2. Choosing the X-Y display format displays channel 1 on the horizontal axis and channel 2 on the vertical axis.

The oscilloscope uses the untriggered sample acquisition mode and waveform data is displayed as dots. The sample rate can vary from 4 kSa/s to 100 MSa/s, and the default sample rate is 1 MSa/s.

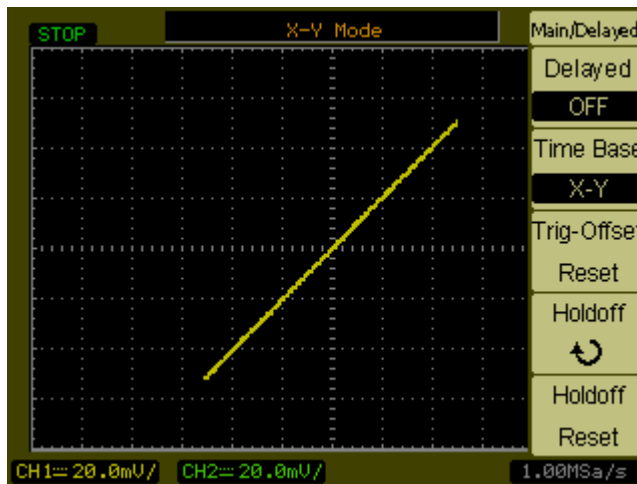

Figure 13 X-Y Display Format Showing In-Phase Waveforms

The following modes or functions are not available in X-Y format:

- Automatic voltage or time measurements.
- Cursor measurements.
- Mask testing.
- Math function waveforms.
- Reference waveforms.
- Delayed sweep time base display.
- Displaying waveforms as vectors.

2 Displaying Data

- Horizontal position knob.
- Trigger controls.

To reset the trigger offset

Turning the horizontal position knob changes the position of the trigger point relative to the center of the screen. To return the trigger position to the center of the screen:

- 1 Press **Main/Delayed**.
- 2 In the Main/Delayed menu, press **Trig-Offset Reset**.

To specify a trigger holdoff

Trigger holdoff can be used to stabilize a waveform. The holdoff time is the oscilloscope's waiting period before starting a new trigger. During the holdoff time oscilloscope will not trigger until the holdoff has expired.

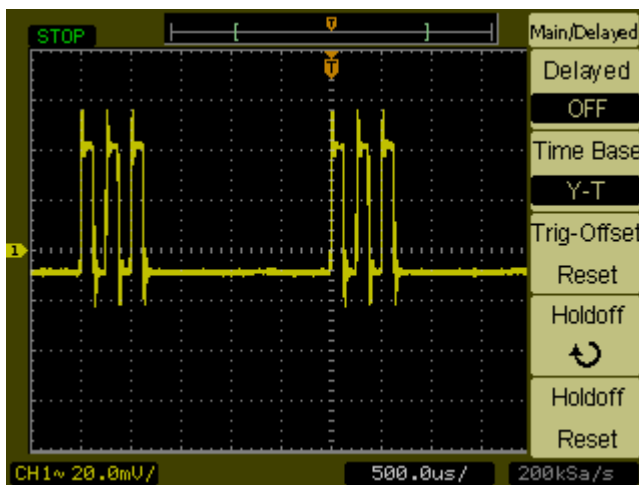

Figure 14 Trigger Holdoff

To specify a trigger holdoff:

- 1 Press **Main/Delayed**.
- 2 In the Main/Delayed menu, select **Holdoff** and turn the **Entry** knob to adjust the holdoff setting.

To reset the trigger holdoff

- 1 In the Main/Delayed menu, select the **Holdoff Reset** menu item to return the trigger holdoff setting to the 100 ns minimum value.

To view the sample rate

The sample rate used for the current horizontal scale setting is displayed at the bottom right-hand corner of the screen.

When the equivalent-time sampling mode is selected (see [“Choosing the Sampling Mode”](#) on page 68), the effective sample rate is displayed.

See Also [“Memory Depth and Sample Rate”](#) on page 67.

Using the Vertical Controls

The vertical controls consist of:

- The channel (**1**, **2**), **Math**, and **Ref** buttons – turn waveforms on or off (and display or hide their menus).
- The vertical scale knobs – change the amplitude per division setting for a waveform, using ground as a reference.
- The vertical position knobs – change the vertical position of the waveform on the screen.

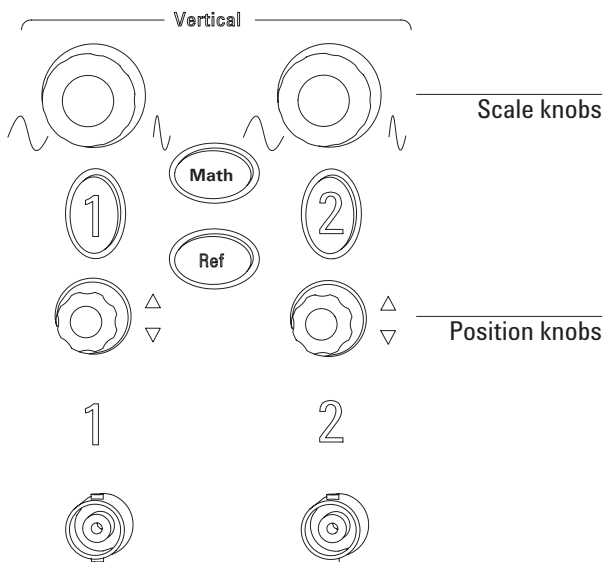

Figure 15 Vertical Controls

To turn waveforms on or off (channel, math, or reference)

In these situations, pressing the channel (**1**, **2**), **Math**, or **Ref** buttons have the following effect:

- If the waveform is off, the waveform is turned on and its menu is displayed.
- If the waveform is on and its menu is not displayed, its menu will be displayed.
- If the waveform is on and its menu is displayed, the waveform is turned off and its menu goes away.

To adjust the vertical scale

When an input channel waveform is on:

- Turn its vertical scale knob to change the amplitude per division setting.

The amplitude/div setting changes in a 1-2-5 step sequence from 2 mV/div to 10 V/div (with “1X” probe attenuation).

Ground is used as a reference.

- Push its vertical scale knob to toggle between vernier (fine scale) adjustment and normal adjustment.

With vernier adjustment, the amplitude/div setting changes in small steps between the normal (coarse scale) settings.

Vernier adjustment is not available for math function or reference waveforms.

The amplitude/div setting is displayed in the status bar at the bottom of the screen.

To adjust the vertical position

Adjusting their vertical position lets you compare waveforms by aligning them above one another or on top of each other.

When an input channel waveform is on:

- Turn the vertical position knob to change the vertical position of the waveform on the screen.

Notice that the ground reference symbol on the left side of the display moves with the waveform.

Notice that, as you adjust the vertical position, a message showing the position of the ground reference relative to the center of the screen is temporarily displayed in the lower left-hand corner of the screen.

To specify channel coupling

1 If the channel's menu is not currently displayed, press the channel button (**1**, **2**).

2 In the Channel menu, press **Coupling** to select between:

- DC – passes both DC and AC components of the input waveform to the oscilloscope. See [Figure 16](#).

You can quickly measure the DC component of the waveform by simply noting its distance from the ground symbol.

- AC – blocks the DC component of the input waveform and passes the AC component. See [Figure 17](#).

This lets you use greater sensitivity (amplitude/div settings) to display the AC component of the waveform.

- GND – the waveform is disconnected from the oscilloscope input. See [Figure 18](#).

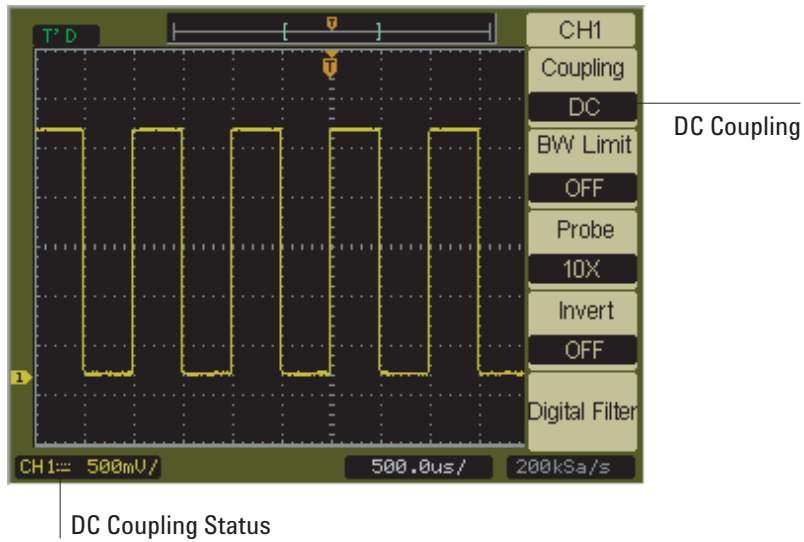

Figure 16 DC Coupling Control

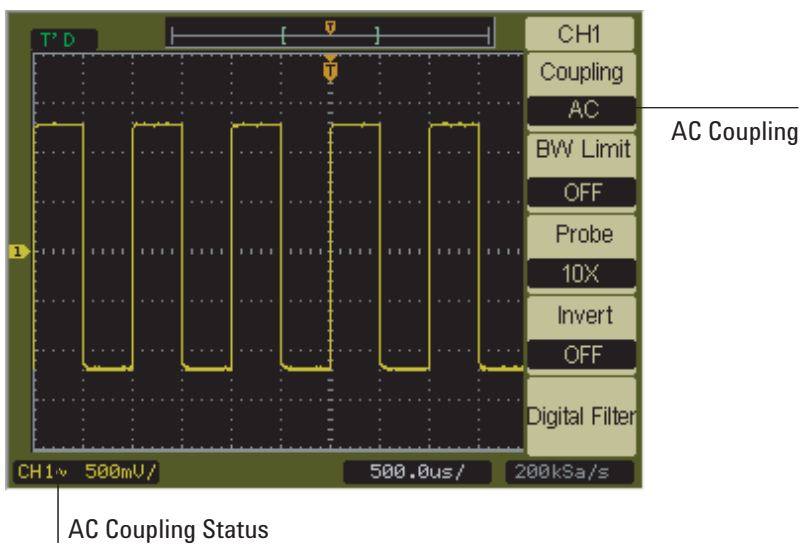

Figure 17 AC Coupling Control

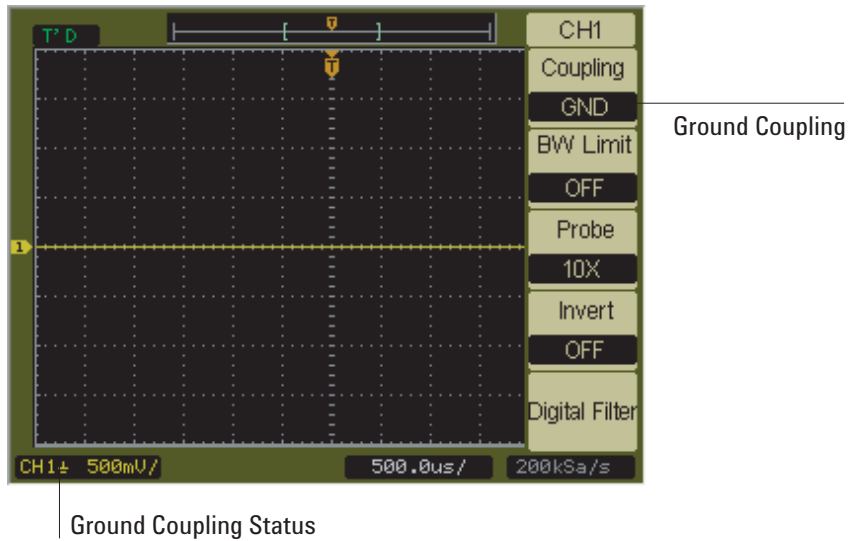

Figure 18 GND Coupling Control

To specify a bandwidth limit

When high frequency components of a waveform are not important to its analysis, the bandwidth limit control can be used to reject frequencies above 20 MHz. See [Figure 19](#) and [Figure 20](#).

- 1 If the channel's menu is not currently displayed, press the channel button (1, 2).
- 2 In the Channel menu, select **BW Limit** to toggle the bandwidth limit setting "ON" and "OFF".

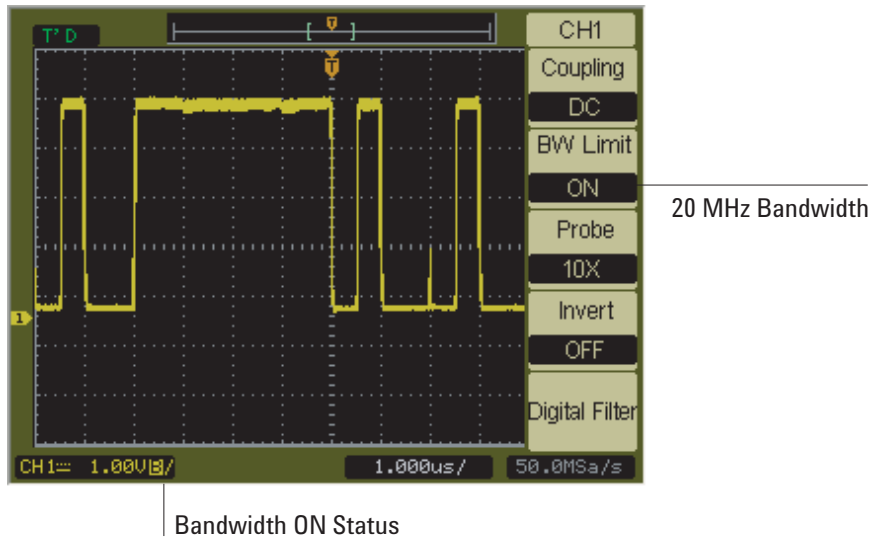

Figure 19 BW Limit Control ON

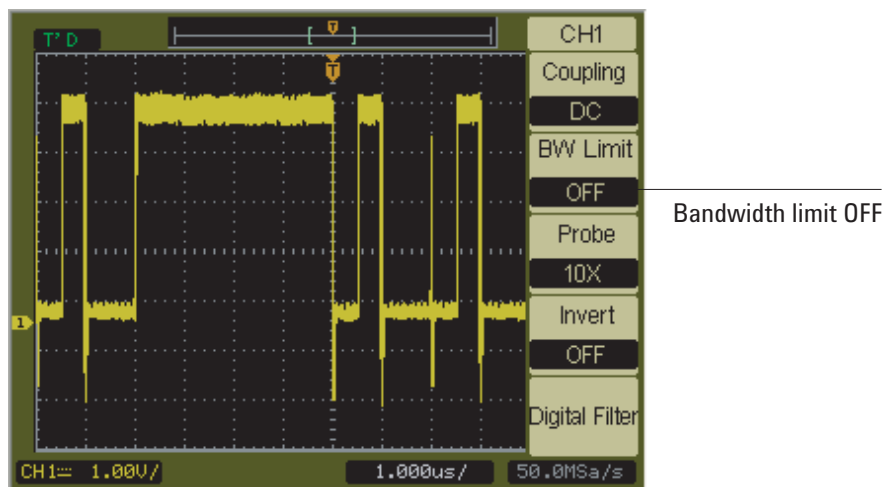

Figure 20 BW Limit Control OFF

To specify the probe attenuation

For correct measurements, you must match the oscilloscope's probe attenuation factor settings with the attenuation factors of the probes being used.

The probe attenuation factor setting changes the vertical scaling of the oscilloscope so that the measurement results reflect the actual voltage levels at the probe tip.

- 1 If the channel's menu is not currently displayed, press the channel button (1, 2).
- 2 In the Channel menu, press **Probe** to select between:
 - 1X – for 1:1 probes.
 - 10X – for 10:1 probes.
 - 100X – for 100:1 probes.
 - 1000X – for 1000:1 probes.

Figure 21 shows an example selecting the probe attenuation factor for a 1000:1 probe.

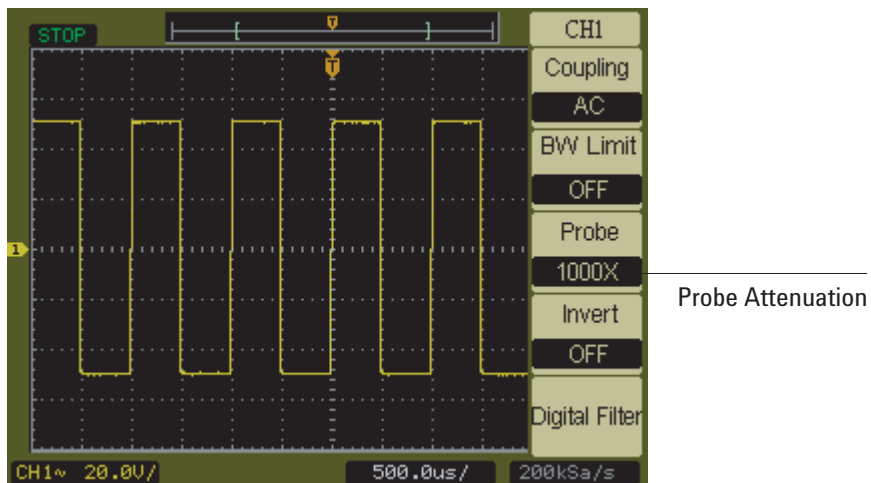
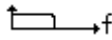
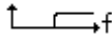
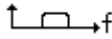
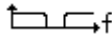

Figure 21 Probe Attenuation Set to 1000:1

To use a digital filter

You can apply a digital filter to the sampled waveform data.

- 1 If the channel's menu is not currently displayed, press the channel button (**1**, **2**).
- 2 In the Channel menu, select **Digital Filter**.
- 3 In the Filter menu, press the **Filter Type** menu button to select between:
 -  – Low Pass Filter.
 -  – High Pass Filter.
 -  – Band Pass Filter.
 -  – Band Reject Filter.
- 4 Depending on the type of filter selected, select **Upper Limit** and/or **Lower Limit**, and turn the **Entry** knob to adjust the limit.

The horizontal scale control sets the maximum value for the upper and lower limits.

To invert a waveform

You can invert a waveform with respect to the ground level.

- 1 If the channel's menu is not currently displayed, press the channel button (**1**, **2**).
- 2 In the Channel menu, select **Invert** to toggle between “ON” and “OFF”.

[Figure 22](#) and [Figure 23](#) show the changes before and after inversion.

2 Displaying Data

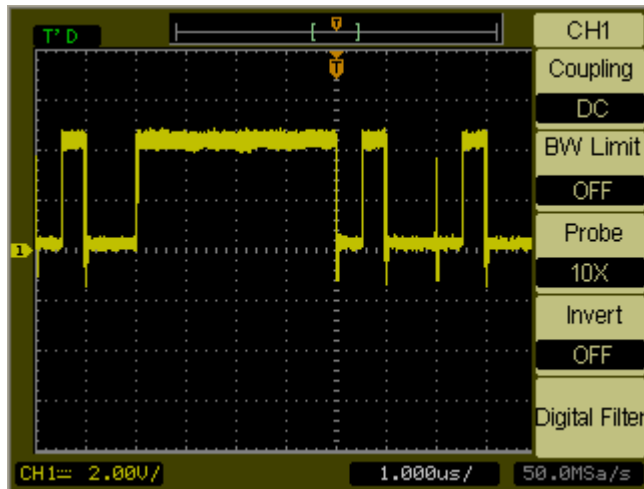

Figure 22 Waveform Before Inversion

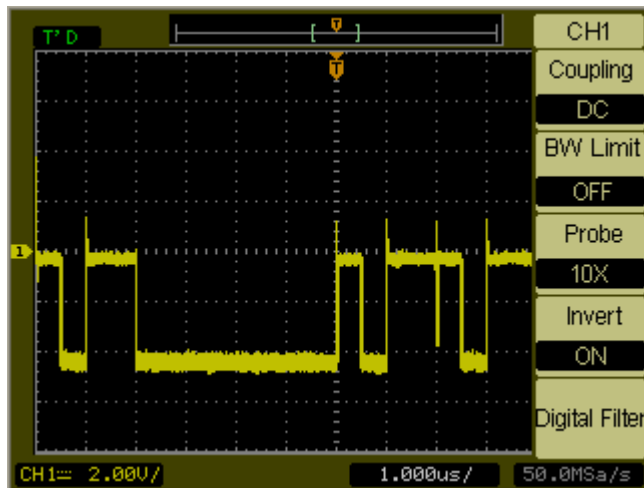

Figure 23 Waveform After Inversion

Using Math Function Waveforms

The math functions control allows the selection of the math functions:

- Add.
- Subtract.
- Multiply.
- FFT (Fast Fourier Transform).

The mathematical result can be measured using the grid and cursor controls.

The amplitude of the math waveform can be adjusted by selecting a menu item and turning the **Entry** knob. The adjustment range is in a 1-2-5 step from 0.1% to 1000%.

The math scale setting is displayed on the status bar.

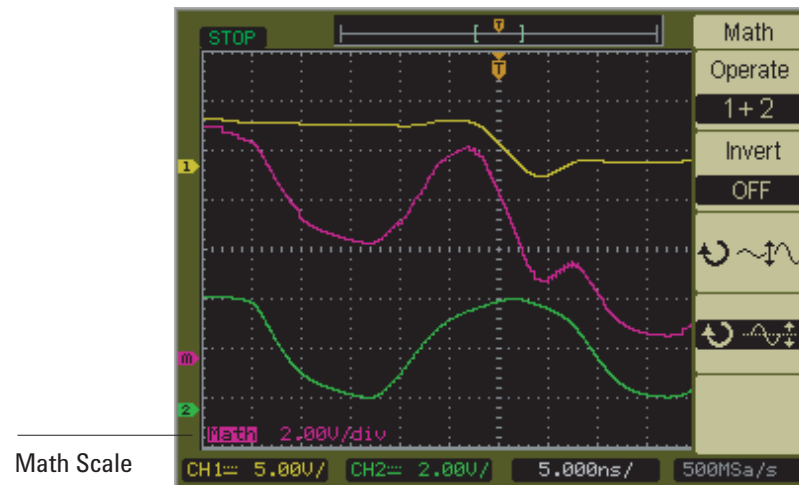

Figure 24 Math Scale Setting Value

To add, subtract, or multiply waveforms

- 1 Press **Math**.
- 2 In the Math menu, press **Operate** to select:
 - 1 + 2
 - 1 - 2
 - 1 x 2
- 3 To invert the result of the addition, subtraction, or multiplication (with respect to the reference level), select **Invert** to toggle between “ON” and “OFF”.

To display the frequency domain using FFT

The FFT math function mathematically converts a time-domain waveform into its frequency components. FFT waveforms are useful for finding the harmonic content and distortion in systems, for characterizing noise in DC power supplies, and for analyzing vibration.

To display a waveform’s FFT:

- 1 Press **Math**.
- 2 In the Math menu, press **Operate** until “FFT” is selected.
- 3 In the FFT menu, press **Source** until the desired input channel is selected.

NOTE

The FFT of a waveform that has a DC component or offset can cause incorrect FFT waveform magnitude values. To minimize the DC component, choose AC Coupling on the source waveform.

To reduce random noise and aliasing components (in repetitive or single-shot waveforms), set the oscilloscope acquisition mode to averaging.

4 Press **Window** until the desired window is selected:

There are four FFT windows. Each window has trade-offs between frequency resolution and amplitude accuracy. What you want to measure and your source waveform characteristics help determine which window to use. Use the guidelines in [Table 3](#) to select the best window.

Table 3 FFT Window Characteristics

Window	Characteristics	Best for measuring
Rectangle	Best frequency resolution, worst magnitude resolution. This is essentially the same as no window.	Transients or bursts, the waveform levels before and after the event are nearly equal. Equal-amplitude sine waves with fixed frequencies. Broadband random noise with a relatively slow varying spectrum.
Hanning, Hamming	Better frequency, poorer magnitude accuracy than Rectangular. Hamming has slightly better frequency resolution than Hanning.	Sine, periodic, and narrow-band random noise. Transients or bursts where the waveform levels before and after the events are significantly different.
Blackman	Best magnitude, worst frequency resolution.	Single frequency waveforms, to find higher order harmonics.

5 Select **Display** to toggle between a “Split” screen display and a “Full Screen” display.

6 Select **Scale** to toggle between “ V_{RMS} ” and “ dBV_{RMS} ” units.

NOTE

To display FFT waveforms with a large dynamic range, use the dBV_{rms} scale. The dBV_{rms} scale displays component magnitudes using a log scale.

7 Use the remaining menu items and the **Entry** knob to position and scale the FFT waveform.

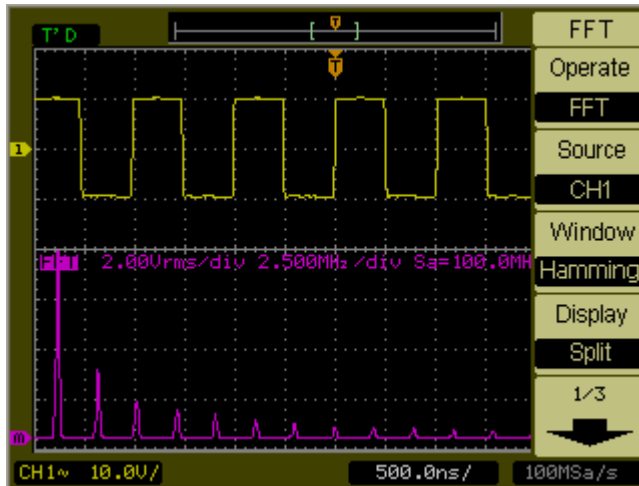

Figure 25 FFT Waveform

NOTE

FFT Resolution

The FFT resolution is the quotient of the sampling rate and the number of FFT points (f_s/N). With a fixed number of FFT points (1024), the lower the sampling rate, the better the resolution.

NOTE

Nyquist Frequency and Aliasing in the Frequency Domain

The Nyquist frequency is the highest frequency that any real-time digitizing oscilloscope can acquire without aliasing. This frequency is half of the sample rate. Frequencies above the Nyquist frequency will be under sampled, which causes aliasing. The Nyquist frequency is also called the folding frequency because aliased frequency components *fold back* from that frequency when viewing the frequency domain.

Using a Reference Waveform

You can save a reference waveform to an internal, nonvolatile memory location and then display it on the oscilloscope along with other captured waveforms.

Reference waveforms are displayed (that is, turned on/off) just like other waveforms (see [page 45](#)).

NOTE

The reference waveform function is not available in X-Y mode.

To save a reference waveform

- 1 Press **Ref**.
- 2 In the Ref menu, press **Source** until the waveform you want to save is selected.
- 3 Press **Save**.
- 4 To invert the reference waveform (with respect to the reference level), select **Invert** to toggle between “ON” and “OFF”.
- 5 Use the remaining menu items and the **Entry** knob to position and scale the reference waveform.

To position, scale, and invert a reference waveform

- 1 Press **Ref** to turn on the reference waveform and access the Ref menu.
- 2 In the Ref menu:
 - To invert the reference waveform (with respect to the reference level), press **Invert** to toggle between “ON” and “OFF”.
 - Use the remaining menu items and the **Entry** knob to position and scale the reference waveform.

Changing the Display Settings

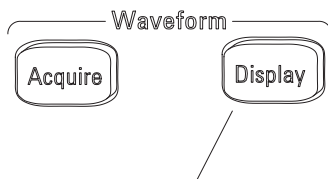





Figure 26 Display Button

To display waveforms as vectors or dots

- 1 Press **Display**.
- 2 In the Display menu, select **Type** to toggle the waveform display between:
 - Vectors – the oscilloscope connects the sample points by using digital interpolation.
Digital interpolation maintains linearity by using a $\sin(x)/x$ digital filter. The digital interpolation is suitable for real time sampling and is most effective at 20 ns or faster horizontal scale settings.
 - Dots – the sample points are displayed.

To change the grid

- 1 Press **Display**.
- 2 In the Display menu, press **Grid** to select between:
 -  – display grid and coordinates on the axes.
 -  – displays coordinates on the axes.
 -  – turns off the grid and coordinates.





To use waveform persistence

- 1 Press **Display**.
- 2 In the Display menu, select **Persist** to toggle the waveform display between:
 - Infinite – sample points remain displayed until the display is cleared or persistence is set to “OFF”.
 - OFF.

To clear the display

- 1 Press **Display**.
- 2 In the Display menu, select **Clear**.

To adjust the display brightness

- 1 Press **Display**.
- 2 In the Display menu, select:
 -   – to increase the display brightness.
 -   – to decrease the display brightness.

To change the menu display time

The menu display time is how long menus remain on the screen after a menu button has been pressed.

- 1 Press **Display**.
- 2 In the Display menu, press **Menu Display** to select “1s”, “2s”, “5s”, “10s”, “20s”, or “Infinite” menu display time.

To invert screen colors

- 1 Press **Display**.
- 2 In the Display menu, select **Screen** to toggle the screen between “Normal” or “Inverted” colors.

Inverted screen colors are sometimes useful when printing or saving screens.



3 Capturing Data

Overview of Sampling	62
Choosing the Sampling Mode	68
Choosing the Acquisition Mode	72
Adjusting the Trigger Level	76
Choosing the Trigger Mode	78
Setting Other Trigger Parameters	82
Using the External Trigger Input	83
Recording/Playing-back Waveforms	83

This chapter describes sampling and acquisition modes and how to set up triggers.



Overview of Sampling

To understand the oscilloscope's sampling and acquisition modes, it is helpful to understand sampling theory, aliasing, oscilloscope bandwidth and sample rate, oscilloscope rise time, oscilloscope bandwidth required, and how memory depth affects sample rate.

Sampling Theory

The Nyquist sampling theorem states that for a limited bandwidth (band-limited) signal with maximum frequency f_{MAX} , the equally spaced sampling frequency f_S must be greater than twice the maximum frequency f_{MAX} , in order to have the signal be uniquely reconstructed without aliasing.

$$f_{MAX} = f_S/2 = \text{Nyquist frequency } (f_N) = \text{folding frequency}$$

Aliasing

Aliasing occurs when signals are under-sampled ($f_S < 2f_{MAX}$). Aliasing is the signal distortion caused by low frequencies falsely reconstructed from an insufficient number of sample points.

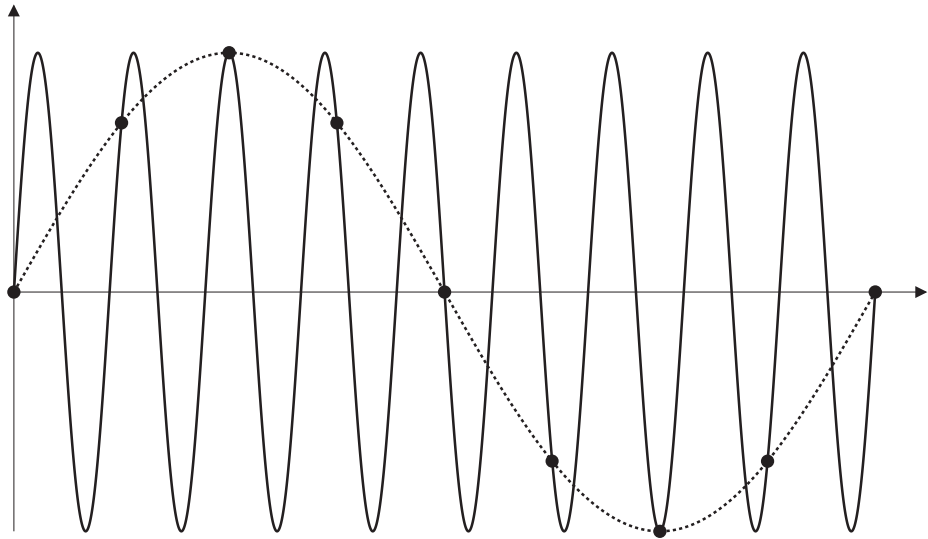

Figure 27 Aliasing

Oscilloscope Bandwidth and Sample Rate

An oscilloscope's bandwidth is typically described as the lowest frequency at which input signal sine waves are attenuated by 3 dB (-30% amplitude error).

At the oscilloscope bandwidth, sampling theory says the required sample rate is $f_S = 2f_{BW}$. However, the theory assumes there are no frequency components above f_{MAX} (f_{BW} in this case) and it requires a system with an ideal brick-wall frequency response.

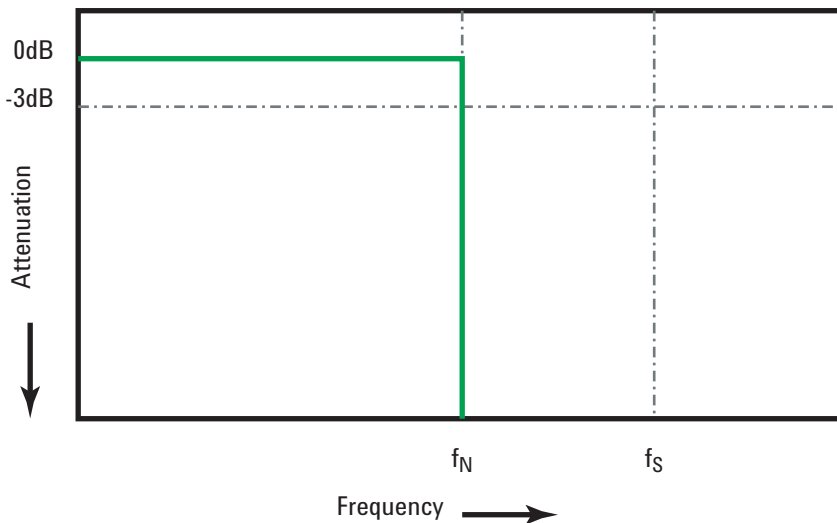
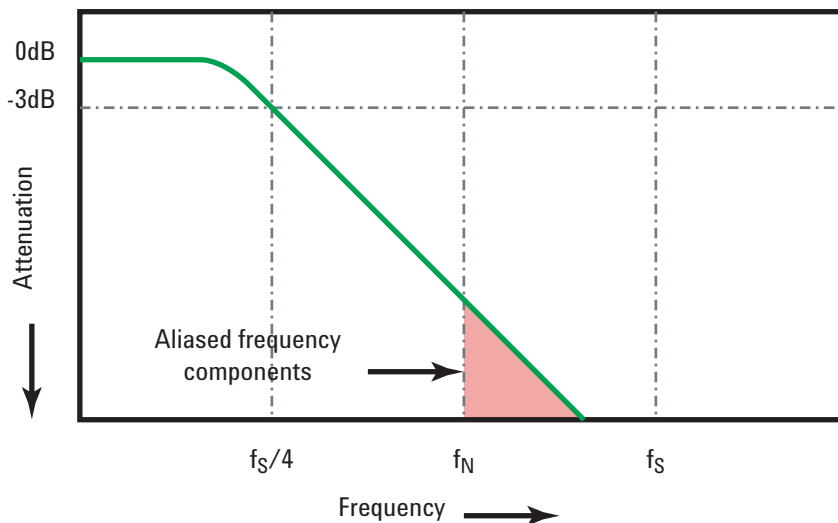

Figure 28 Theoretical Brick-Wall Frequency Response

However, digital signals have frequency components above the fundamental frequency (square waves are made up of sine waves at the fundamental frequency and an infinite number of odd harmonics), and typically, for 1 GHz bandwidths and below, oscilloscopes have a Gaussian frequency response.



Limiting oscilloscope bandwidth (f_{BW}) to 1/4 the sample rate ($f_S/4$) reduces frequency components above the Nyquist frequency (f_N).

Figure 29 Sample Rate and Oscilloscope Bandwidth

So, in practice, an oscilloscope's sample rate should be four or more times its bandwidth: $f_S = 4f_{BW}$. This way, there is less aliasing, and aliased frequency components have a greater amount of attenuation.

See Also *Evaluating Oscilloscope Sample Rates vs. Sampling Fidelity: How to Make the Most Accurate Digital Measurements*, Agilent Application Note 1587 (<http://cp.literature.agilent.com/litweb/pdf/5989-5732EN.pdf>)

Oscilloscope Rise Time

Closely related to an oscilloscope's bandwidth specification is its rise time specification. Oscilloscopes with a Gaussian-type frequency response have an approximate rise time of $0.35/f_{BW}$ based on a 10% to 90% criterion.

An oscilloscope's rise time is not the fastest edge speed that the oscilloscope can accurately measure. It is the fastest edge speed the oscilloscope can possibly produce.

Oscilloscope Bandwidth Required

The oscilloscope bandwidth required to accurately measure a signal is primarily determined by the signal's rise time, not the signal's frequency. You can use these steps to calculate the oscilloscope bandwidth required:

- 1 Determine the fastest edge speeds.

You can usually obtain rise time information from published specifications for devices used in your designs.

- 2 Compute the maximum "practical" frequency component.

From Dr. Howard W. Johnson's book, *High-Speed Digital Design - A Handbook of Black Magic*, all fast edges have an infinite spectrum of frequency components. However, there is an inflection (or "knee") in the frequency spectrum of fast edges where frequency components higher than f_{knee} are insignificant in determining the shape of the signal.

$$f_{\text{knee}} = 0.5 / \text{signal rise time (based on 10\% - 90\% thresholds)}$$

$$f_{\text{knee}} = 0.4 / \text{signal rise time (based on 20\% - 80\% thresholds)}$$

- 3 Use a multiplication factor for the required accuracy to determine the oscilloscope bandwidth required.

Required accuracy	Oscilloscope bandwidth required
20%	$f_{\text{BW}} = 1.0 \times f_{\text{knee}}$
10%	$f_{\text{BW}} = 1.3 \times f_{\text{knee}}$
3%	$f_{\text{BW}} = 1.9 \times f_{\text{knee}}$

See Also *Choosing an Oscilloscope with the Right Bandwidth for your Application*, Agilent Application Note 1588 (<http://cp.literature.agilent.com/litweb/pdf/5989-5733EN.pdf>)

Memory Depth and Sample Rate

The number of points of oscilloscope memory is fixed, and there is a maximum sample rate associated with oscilloscope's analog-to-digital converter; however, the actual sample rate is determined by the time of the acquisition (which is set according to the oscilloscope's horizontal time/div scale).

$$\text{sample rate} = \text{number of samples} / \text{time of acquisition}$$

For example, when storing 5 μ s of data in 4,000 points of memory, the actual sample rate is 800 MSa/s.

Likewise, when storing 500 ms of data in 4,000 points of memory, the actual sample rate is 8 kSa/s.

The actual sample rate, is displayed in the horizontal Main/Delayed menu (see [“To view the sample rate”](#) on page 43).

The oscilloscope achieves the actual sample rate by throwing away (decimating) unneeded samples.

Choosing the Sampling Mode

The oscilloscope can operate in real-time or equivalent-time sampling modes.

You can choose the oscilloscope's sampling mode in the Acquire menu (accessed by pressing the **Acquire** front panel button).

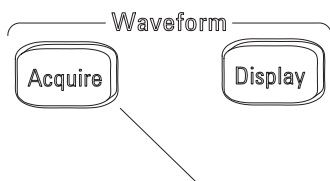

Figure 30 Acquire Button

To select the real-time sampling mode

In the real-time sampling mode, single waveforms are sampled at uniformly spaced intervals. See [Figure 31](#).

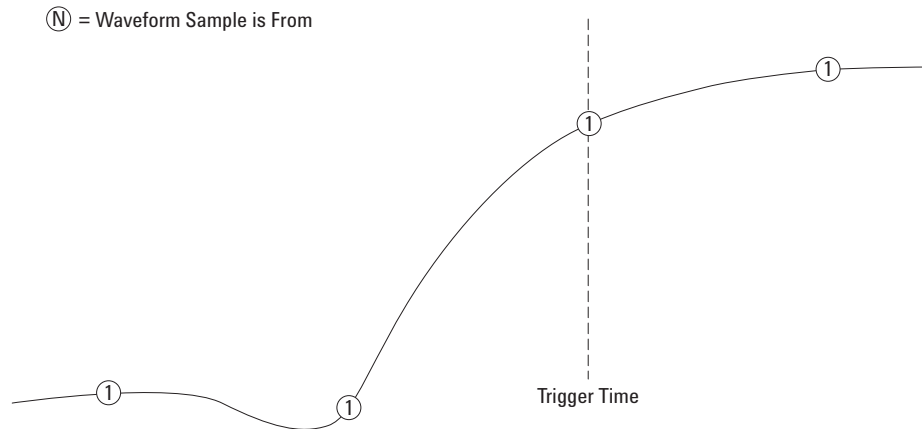

Figure 31 Real-Time Sampling Mode

Use the real-time sampling mode when capturing (non-repetitive) single-shot or pulse waveforms.

The 3000 Series oscilloscopes provide real-time sampling rates up to 1 GSa/s.

To select the Real-Time sampling mode:

- 1 Press **Acquire**.
- 2 In the Acquire menu, select **Sampling** to choose the “Real Time” sampling mode.

In the real-time sampling mode, when the horizontal scale is set to 20 ns or faster, the oscilloscope uses sine(x)/x interpolation to expand the horizontal time base.

To select the equivalent-time sampling mode

In the equivalent-time sampling mode (also known as repetitive sampling), multiple waveforms are sampled using randomly differing delays from the trigger to yield higher effective sampling rates.

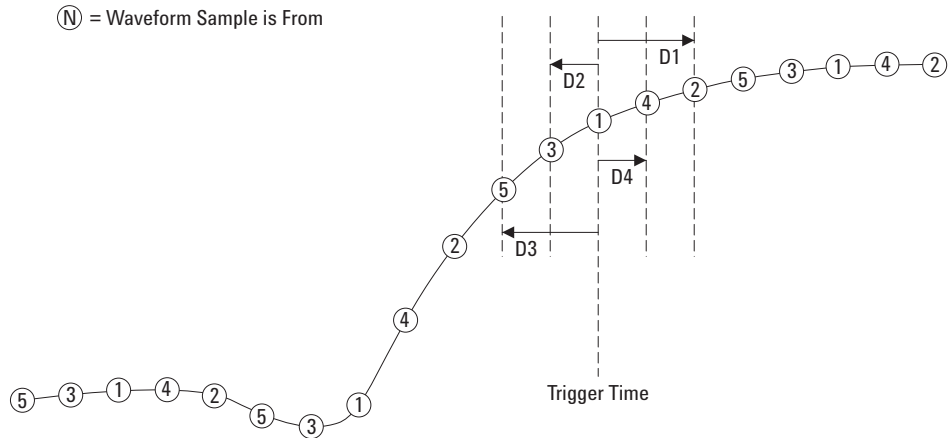

Figure 32 Equivalent-Time (Repetitive) Sampling Mode

In the equivalent-time sampling mode, the *effective sample rate* can be greater because the time between samples in the acquisition is shorter.

Equivalent-time sampling mode requires a repetitive waveform with a stable trigger.

Use the equivalent-time sampling mode to capture repetitive high-frequency signals at greater sample rates than are available in the real-time sampling mode.

Do not use the equivalent-time mode for single-shot events or pulse waveforms.

The benefits of the equivalent-time sampling mode are negligible when sample rates are the same as available in the real-time sampling mode.

In the 3000 Series oscilloscopes, the equivalent time sampling mode can achieve up to 20 ps of horizontal resolution (equivalent to 50 GSa/s).

To select the Equivalent-Time sampling mode:

- 1 Press **Acquire**.
- 2 In the Acquire menu, select **Sampling** to choose the “Equ-Time” sampling mode.

Choosing the Acquisition Mode

The oscilloscope can operate in normal, average, or peak detect acquisition modes.

You can choose the oscilloscope's acquisition mode in the Acquire menu (accessed by pressing the **Acquire** front panel button – see [page 68](#)).

To select the Normal acquisition mode

In the Normal acquisition mode, acquisitions are made according to the selected sampling mode, and they are displayed one after the other.

To select the Normal acquisition mode:

- 1 Press **Acquire**.
- 2 In the Acquire menu, press **Acquisition** until “Normal” is selected.

To select the Average acquisition mode

In the Average acquisition mode, acquisitions are made according to the selected sampling mode, and the running average over the specified number of acquisitions is displayed.

Use the Average acquisition mode to remove random noise from the waveform and to improve measurement accuracy.

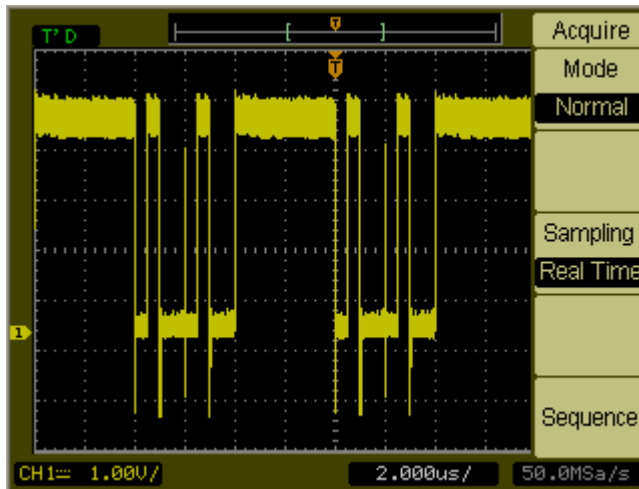

Figure 33 Noisy Waveform Without Averaging

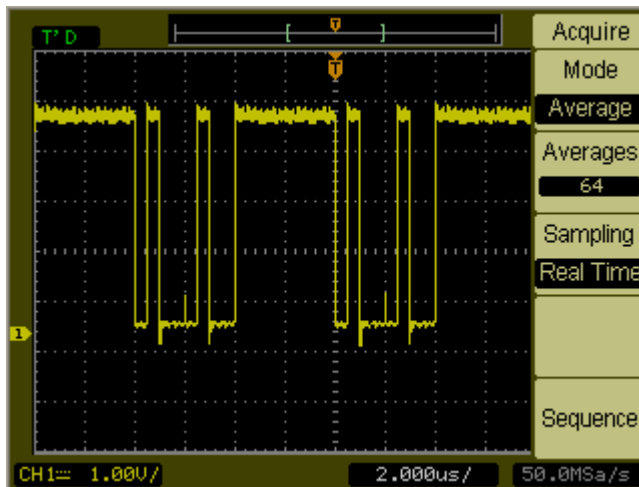

Figure 34 Noisy Waveform With Averaging

The Average acquisition mode decreases the screen refresh rate.

To select the Average acquisition mode:

- 1 Press **Acquire**.
- 2 In the Acquire menu, press **Acquisition** until “Average” is selected.
- 3 Press **Averages** to select the desired number (2, 4, 8, 16, 32, 64, 128, or 256).

To select the Peak Detect acquisition mode

In Normal or Average acquisition modes, at longer horizontal time/div settings, the oscilloscope’s analog-to-digital converter samples at a rate that yields more samples than can be stored in a limited amount of oscilloscope memory. Consequently, samples are thrown away (decimated), and you can miss narrow excursions on a signal.

However, in the Peak Detect acquisition mode, acquisitions are made at the fastest sample rate, and the minimum and maximum values for the period associated with the actual sample rate are stored. This way, you can capture narrow excursions on a signal at longer horizontal time/div settings.

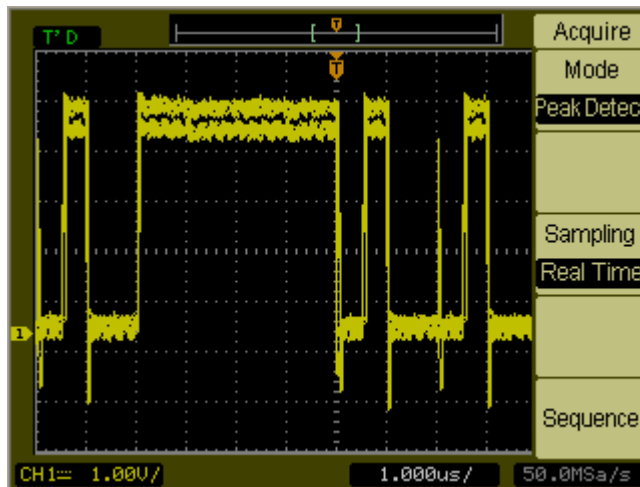

Figure 35 Peak Detect Waveform

Because minimum and maximum values for a sample period are stored, you can use the Peak Detect acquisition mode to avoid waveform aliasing.

To select the Peak Detect acquisition mode:

- 1 Press **Acquire**.
- 2 In the Acquire menu, press **Acquisition** until “Peak Detect” is selected.

Adjusting the Trigger Level

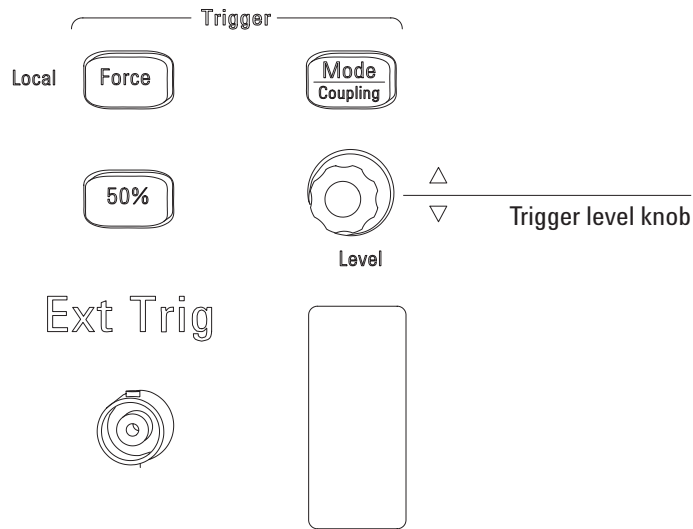

Figure 36 Trigger Controls

To adjust the trigger level

- Turn the trigger **Level** knob.
 - Two things happen:
 - The trigger level value is displayed at the lower left-hand corner of the screen. If the trigger is DC coupled, it is displayed as a voltage. If the trigger is AC coupled or LF reject coupled, it is displayed as a percentage of the trigger range.
 - A line is displayed showing the location of the trigger level with respect to the waveform (except when using AC coupling or LF reject coupling modes).
- Push **50%** to set the level at 50% of the signal's vertical amplitude.

To force a trigger

To make an acquisition even if no valid trigger has been found:

1 Press **Force**.

Forcing a trigger is useful, for example, when you want to display the DC voltage of a level signal.

The **Force** button has no effect if the acquisition is already stopped.

“Local” Function of Force Button

When the oscilloscope is being controlled by a remote program, “Rmt” appears in red in the upper right corner of the display. To return control to the oscilloscope’s front panel, press the **Force** button.

Choosing the Trigger Mode

The trigger determines when captured data should be stored and displayed.

When a trigger is set up properly, it can convert unstable displays or blank screens into meaningful waveforms.

When the oscilloscope starts to acquire a waveform, it collects enough data so that it can draw the waveform to the left of the trigger point. The oscilloscope continues to acquire data while waiting for the trigger condition to occur. After it detects a trigger, the oscilloscope continues to acquire enough data so that it can draw the waveform to the right of the trigger point.



The oscilloscope provides these trigger modes:

- Edge – can be used with analog and digital circuits. An edge trigger occurs when the trigger input passes through a specified voltage level with the specified slope.
- Pulse – is used to find pulses with certain widths.
- Video – is used to trigger on fields or lines for standard video waveforms.

To set up edge triggers

- 1 Press **Mode/Coupling**.
- 2 In the Trigger menu, press **Mode** until “Edge” is selected.
- 3 Press **Source** until the desired waveform to trigger on is selected:
 - CH1
 - CH2
 - EXT – the external trigger input.
 - EXT/5 – the (5:1) attenuated external trigger input.
 - AC Line – the AC power line.

4 Press **Slope** to select the edge to trigger on:

-  – Rising edge.
-  – Falling edge.

To set up pulse width triggers

A pulse width trigger occurs when a pulse is found in a waveform that matches the pulse definition.







1 Press **Mode/Coupling**.

2 In the Trigger menu, press **Mode** until “Pulse” is selected.

3 Press **Source** to select the waveform to trigger on:

- CH1
- CH2
- EXT – the external trigger input.
- EXT/5 – the (5:1) attenuated external trigger input.

4 Press **When** to select the type of pulse to trigger on:

-  – Positive pulse greater than the width setting.
-  – Positive pulse less than the width setting.
-  – Positive pulse equal to the width setting.
-  – Negative pulse greater than the width setting.
-  – Negative pulse less than the width setting.
-  – Negative pulse equal to the width setting.

5 Press **Setting** and turn the **Entry** knob to adjust the width setting.

The width setting can be adjusted from 20 ns to 10 s.

To set up video triggers



Video triggering is used to trigger on fields or lines of NTSC, PAL, or SECAM standard video waveforms.

When the video trigger mode is selected, the trigger coupling is set to AC.

1 Press **Mode/Coupling**.

2 In the Trigger menu, press **Mode** until “Video” is selected.

3 Select **Polarity** to toggle between:

-  Normal polarity – trigger on the negative edge of the sync pulse.
-  Inverted polarity – trigger on the positive edge of the sync pulse.

NOTE

Normal Polarity Sync triggers always occur on negative-going horizontal sync pulses. If the video waveform has positive-going horizontal sync pulses, use the Inverted Polarity selection.

4 Press **Sync** to select what to trigger on:

- All Lines – trigger on all lines.
- Line Num – trigger on a selected line.

If you select “Line Num”, select the following **Line Num** menu item and turn the **Entry** knob to select the line number.

- Odd Field – trigger on an odd field.
- Even Field – trigger on an even field.

5 Select **Standard** to toggle between:

- NTSC – trigger on an NTSC video waveform.
- PAL/SECAM – trigger on a PAL or SECAM video waveform.

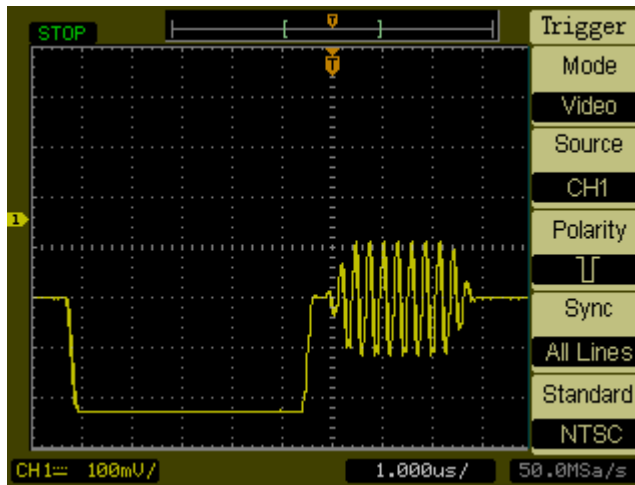

Figure 37 Line Synchronization

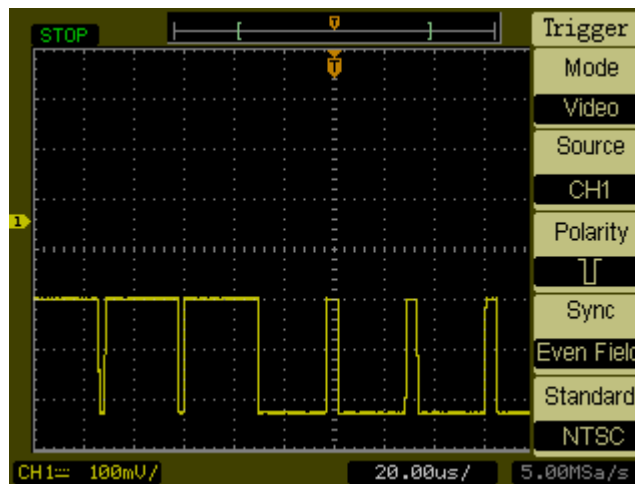

Figure 38 Field Synchronization

Setting Other Trigger Parameters

These are trigger system parameters that apply in all trigger modes.

See Also “To specify a trigger holdoff” on page 42.

“To reset the trigger offset” on page 42.

To set the trigger sweep

Trigger sweep specifies whether acquisitions occur without a trigger or only with a trigger.

- 1 Press **Mode/Coupling**.
- 2 In the Trigger menu, press **Sweep** to select one of these trigger sweep settings:
 - Auto – acquire waveform even when no trigger occurs.
 - Normal – acquire waveform when trigger occurs.

To set the trigger coupling

Trigger coupling is used to filter low or high frequency signal components or DC offsets from the trigger path when they interfere with achieving stable triggers.

Trigger coupling is similar to channel coupling (see [page 46](#)), but it only affects the triggering system and does not change how the signal is displayed.

To set the trigger coupling:

- 1 Press **Mode/Coupling**.

- 2 In the Trigger menu, when “Edge” or “Pulse” is selected for **Mode**, press **Coupling** to select one of these trigger coupling settings:
 - DC – sets the trigger coupling to DC.
 - LF Reject – sets the trigger coupling to high frequency reject (10 kHz cutoff).
 - HF Reject – sets the trigger coupling to low frequency reject (100 kHz cutoff).
 - AC – sets the trigger coupling to AC – use for waveforms greater than 50 Hz.

Using the External Trigger Input

You can trigger on external inputs by selecting “EXT” or “EXT/5” (5:1 attenuated) as the trigger source in all trigger modes.

Recording/Playing-back Waveforms

You can record waveforms from input channels or from the mask test output, with a maximum acquisition depth of 1000 frames.

The ability to record mask test output is especially useful for capturing abnormal waveforms over a long period of time.

To record waveforms

To record waveforms:

- 1 Press **Acquire**.
- 2 In the Acquire menu, select **Sequence**.
- 3 In the Sequence menu, press **Mode** to select “Capture”.



To select the source channel for recording

- 1 In the Sequence menu (**Acquire**→**Sequence**→**Mode=Capture**), press **Source** to select the desired input channel or the mask test output.
To specify the mask test output, see “[To set the mask test output condition](#)” on page 113.

To select the number of frames to record

- 1 In the Sequence menu (**Acquire**→**Sequence**→**Mode=Capture**), select **End Frame**.
- 2 Turn the **Entry** knob to select a number from 1 to 1000.

To start/stop recording

- 1 In the Sequence menu (**Acquire**→**Sequence**→**Mode=Capture**), select **Operate** to start or stop recording.
 -  – Appears on the menu when not recording; press **Operate** to start recording.
 -  – Appears on the menu when recording; press **Operate** to stop recording.

To select the interval between recorded frames



- 1 In the Sequence menu (**Acquire**→**Sequence**→**Mode=Capture**), select **Interval**.
- 2 Turn the **Entry** knob to select an interval from 1 ms to 1000 s.

To play-back waveforms



To play-back waveforms:

- 1 Press **Acquire**.
- 2 In the Acquire menu, select **Sequence**.
- 3 In the Sequence menu, press **Mode** to select “Play back”.

To play-back/stop the recording

- 1 In the Sequence menu (**Acquire**→**Sequence**→**Mode=Play back**), select **Operate** to play-back or stop the recording.
 -  – Appears on the menu when not playing-back; press **Operate** to start playing-back the recording.
 -  – Appears on the menu when playing-back; press **Operate** to stop recording.

To select continuous or one-time play-back

- 1 In the Sequence menu (**Acquire**→**Sequence**→**Mode=Play back**), select **Play Mode** to toggle between:
 -  – Continuous play-back.
 -  – One-time play-back.

To select the interval between played-back frames

- 1 In the Sequence menu (**Acquire**→**Sequence**→**Mode=Play back**), select **Interval**.
- 2 Turn the **Entry** knob to select an interval from 1 ms to 20 s.

To select the start frame

- 1 In the Sequence menu (**Acquire**→**Sequence**→**Mode=Play back**), select **Start Frame**.
- 2 Turn the **Entry** knob to select a number from 1 to 1000.

To select the current frame

- 1 In the Sequence menu (**Acquire**→**Sequence**→**Mode=Play back**), select **Current Frame**.
- 2 Turn the **Entry** knob to select a number from 1 to 1000.

To select the end frame

- 1 In the Sequence menu (**Acquire**→**Sequence**→**Mode=Play back**), select **End Frame**.
- 2 Turn the **Entry** knob to select a number from 1 to 1000.

To store recorded waveforms

To store recorded waveforms:

- 1 Press **Acquire**.
- 2 In the Acquire menu, select **Sequence**.
- 3 In the Sequence menu, press **Mode** to select “Storage”.

To select the start frame

- 1 In the Sequence menu (**Acquire**→**Sequence**→**Mode=Storage**), select **Start Frame**.
- 2 Turn the **Entry** knob to select a number from 1 to 1000.

To select the end frame

- 1 In the Sequence menu (**Acquire**→**Sequence**→**Mode=Storage**), select **End Frame**.
- 2 Turn the **Entry** knob to select a number from 1 to 1000.

To save a recording

- 1 In the Sequence menu (**Acquire**→**Sequence**→**Mode=Storage**), select **Save**.

To load a recording

- 1 In the Sequence menu (**Acquire**→**Sequence**→**Mode=Storage**), select **Load**.



4 Making Measurements

Displaying Automatic Measurements 88

Voltage Measurements 90

Time Measurements 93

Making Cursor Measurements 98

This chapter shows how to make automatic voltage measurements, automatic time measurements, hardware frequency counter measurements, and cursor measurements.



Displaying Automatic Measurements

You can use the **Measure** button to display automatic measurements. The oscilloscope has 20 automatic measurements and a hardware frequency counter (see “[Voltage Measurements](#)” on page 90 and “[Time Measurements](#)” on page 93).

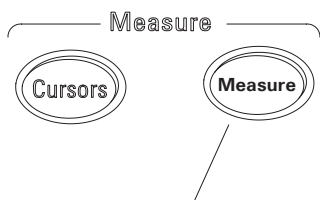

Figure 39 Measure Button

To display an automatic measurement

- 1 Press **Measure**.
- 2 In the Measure menu, select **Source** to select the input channel or math waveform on which to make the automatic measurement.
- 3 Select **Voltage** (for voltage measurements) or **Time** (for time measurements).
- 4 Then, push the menu button for the measurement to add to the bottom of the display.

If the measurement result is displayed as "*****", the measurement cannot be performed with the current oscilloscope settings.

A maximum of three measurements can be displayed at the bottom of the display. When three measurements are displayed and you add a new one, the measurements shift to the left, pushing the first measurement result off screen.

See Also “[To display cursors for automatic measurements](#)” on page 100.

To clear automatic measurements from the display

- 1 Press **Measure**.
- 2 In the Measure menu, select **Clear** to clear all automatic measurements from the display.

To display or hide all automatic measurements

- 1 Press **Measure**.
- 2 In the Measure menu, select **Display All** to toggle the display of all automatic measurements “ON” or “OFF”.

Voltage Measurements

There are 10 automatic voltage measurements:

- Vpp (Peak-to-Peak Voltage).
- Vmax (Maximum Voltage).
- Vmin (Minimum Voltage).
- Vavg (Average Voltage).
- Vamp (Amplitude Voltage = $V_{top} - V_{base}$).
- Vtop (Top Voltage).
- Vbase (Base Voltage).
- Vrms (Root-Mean-Square Voltage).
- Overshoot.
- Preshoot.

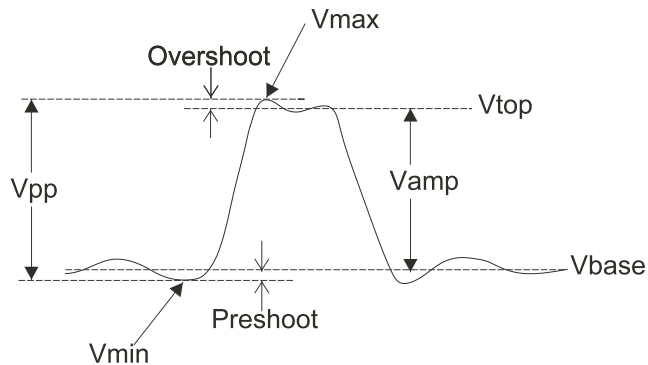

Figure 40 Voltage Measurement Points

Vpp (Peak-to-Peak Voltage)

Peak-to-peak voltage. See [Figure 40](#) on page 90.

Vmax (Maximum Voltage)

The maximum amplitude. The most positive peak voltage measured over the entire waveform. See [Figure 40](#) on page 90.

Vmin (Minimum Voltage)

The minimum amplitude. The most negative peak voltage measured over the entire waveform. See [Figure 40](#) on page 90.

Vavg (Average Voltage)

The arithmetic mean over the entire waveform.

Vamp (Amplitude Voltage = Vtop - Vbase)

Voltage between Vtop and Vbase of a waveform. See [Figure 40](#) on page 90.

Vtop (Top Voltage)

Voltage of the waveform's flat top, useful for square and pulse waveforms. See [Figure 40](#) on page 90.

Vbase (Base Voltage)

Voltage of the waveform's flat base, useful for square and pulse waveforms. See [Figure 40](#) on page 90.

Vrms (Root-Mean-Square Voltage)

The true root-mean-square voltage over the entire waveform.

$$RMS = \sqrt{\frac{\sum_{i=1}^n x_i^2}{n}}$$

Where:

x_i = value at i^{th} point.

n = number of points.

Overshoot

Defined as $(V_{\text{max}} - V_{\text{top}}) / V_{\text{amp}}$, useful for square and pulse waveforms. See [Figure 40](#) on page 90.

Preshoot

Defined as $(V_{\text{min}} - V_{\text{base}}) / V_{\text{amp}}$, useful for square and pulse waveforms. See [Figure 40](#) on page 90.

Time Measurements

There are 10 automatic time measurements plus the hardware frequency counter:

- Frequency.
- Period.
- Rise Time.
- Fall Time.
- + Pulse Width.
- - Pulse Width.
- + Duty Cycle.
- - Duty Cycle.
- Delay 1-2, rising edges.
- Delay 1-2, falling edges.
- Counter (Frequency).

Frequency

Measures the frequency of a waveform. See [Figure 41](#) on page 94.

Period

Measures the period of a waveform.

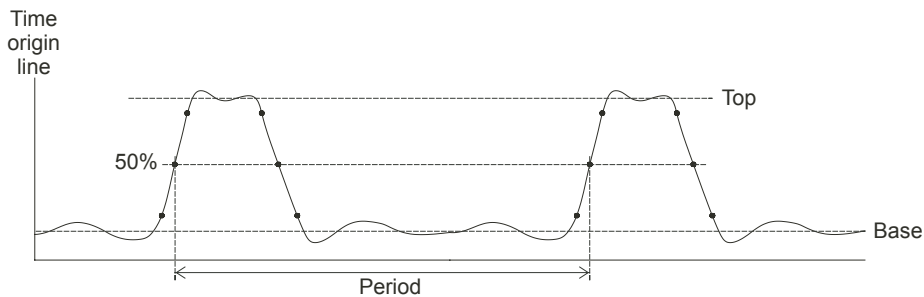

Figure 41 Period and Frequency Measurements

Rise Time

Measures the rise time of a waveform.

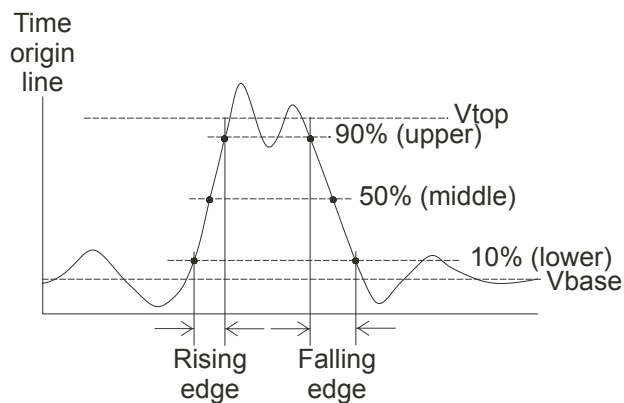

Figure 42 Rise Time and Fall Time Measurements

Fall Time

Measures the fall time of a waveform. See [Figure 42](#) on page 94.

Positive Pulse Width

Measures the positive pulse width of a waveform.

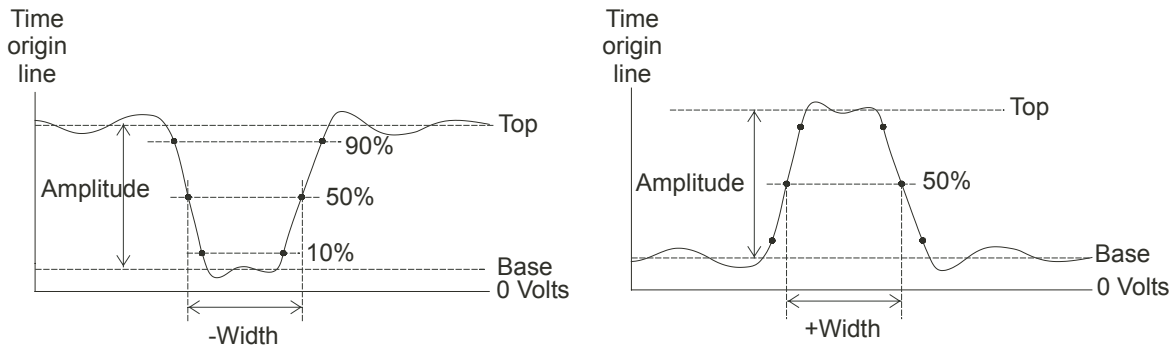

Figure 43 Positive Pulse Width and Negative Pulse Width Measurements

Negative Pulse Width

Measures the negative pulse width of a waveform. See [Figure 43](#) on page 95.

Positive Duty Cycle

Measures the positive duty cycle of a waveform.

Negative Duty Cycle

Measures the negative duty cycle of a waveform.

Delay Between Rising Edges

Measures the delay between two waveforms using the rising edges.

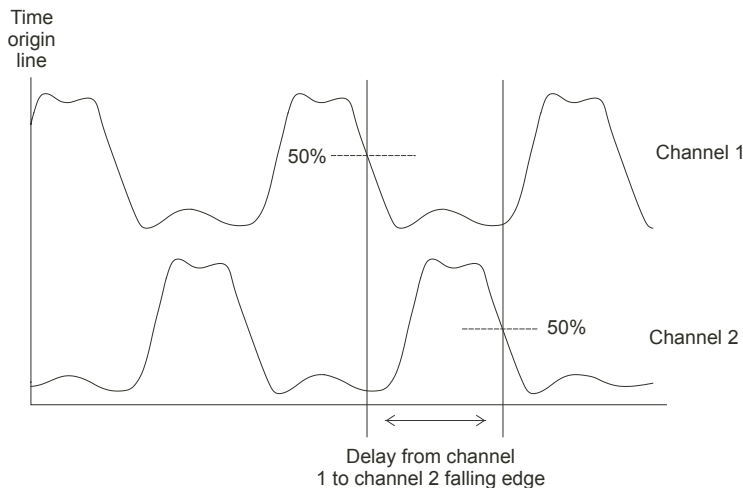

Figure 44 Delay Measurements

Delay Between Falling Edges

Measures the delay between two waveforms using the falling edges. See [Figure 44](#) on page 96.

Counter (Frequency)

The 3000 Series oscilloscopes have an integrated 5-digit hardware frequency counter.

The counter operates on the currently selected trigger source and can measure frequencies from 5 Hz to the bandwidth of the oscilloscope.

The counter uses the trigger comparator to count the number of cycles within a period of time (known as the gate time), so the trigger level must be set correctly.

Making Cursor Measurements

You can use the **Cursors** button to select between these cursor measurement modes:

- Manual – gives you manually adjustable, parallel cursors for measuring time or amplitude between cursors.
- Track – gives you one or two manually adjustable, cross-hair cursors that track the points of a waveform, measuring time and amplitude.
- Auto – gives you automatically adjusted cursors for the most recently displayed voltage or time measurement.
- OFF – cursors are tuned off.

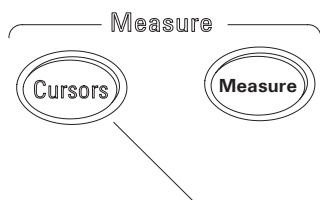

Figure 45 Cursors Button

To use manually adjustable cursors

You can set up two parallel, manually adjustable cursors to make amplitude (vertical) or time (horizontal) measurements on a selected waveform.

- 1 Press **Cursors**.
- 2 In the Cursors menu, press **Mode** until “Manual” is selected.
- 3 Select **Type** to toggle between:
 - Time – to use cursors to measure time parameters.
 - Voltage – to use cursors to measure voltage parameters.
- 4 Press **Source** to select the channel or math waveform on which to make the measurement.

5 To adjust the cursors:

- Select **CurA** and turn the **Entry** knob to adjust the “A” cursor.
- Select **CurB** and turn the **Entry** knob to adjust the “B” cursor.

The cursor values displayed are:

- CurA.
- CurB.
- DeltaX or DeltaY – difference between CurA and CurB values.
- 1/DeltaX – when measuring time parameters, shows the frequency associated with the time period.

To use tracking cross-hair cursors

You can set up one or two manually adjustable, tracking cross-hair cursors to make amplitude (vertical) and time (horizontal) measurements at different points of a selected channel’s waveform.

- 1 Press **Cursors**.
- 2 In the Cursors menu, press **Mode** until “Track” is selected.
- 3 Press **Cursor A** to select the channel on which to make the measurement (or “None” to turn off the cursor).
- 4 Press **Cursor B** to select the channel on which to make the measurement (or “None” to turn off the cursor).
- 5 To adjust the cursors:
 - Select **CurA** and turn the **Entry** knob to adjust the “A” cursor.
 - Select **CurB** and turn the **Entry** knob to adjust the “B” cursor.

The A cursor values displayed are:

- A->X.
- A->Y.

The B cursor values displayed are:

- B->X.
- B->Y.

If both A and B cursors are used, these values are also displayed:

- DeltaX – difference between CurA and CurB time values.
- 1/DeltaX – shows the frequency associated with the time value difference.
- DeltaY – difference between CurA and CurB amplitude values.

To display cursors for automatic measurements

1 Press **Cursors**.

2 In the Cursors menu, press **Mode** until “Auto” is selected.

In the “Auto” cursors mode:

- Cursors appear for the most recently displayed automatic measurement (see “[To display an automatic measurement](#)” on page 88).
- No cursors are displayed if there are no automatic measurements.

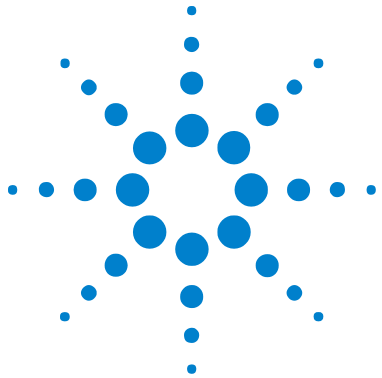

5 Saving, Recalling, and Printing Data

Saving and Recalling Waveforms and Setups	102
Saving to and Recalling from a USB Mass Storage Device	104
Printing the Display to a USB Printer	109

This chapter describes how to save, recall, and print data.

The oscilloscope has internal, nonvolatile memory locations for saving and recalling waveforms and setups.

If the oscilloscope has the USB host port module attached to the rear panel, you can:

- Save data to, and recall waveforms and setups from, a USB mass storage device.
- Print to a USB printer.



Saving and Recalling Waveforms and Setups

Using the oscilloscope's **Save/Recall** button, you can save and load oscilloscope waveforms and setups.

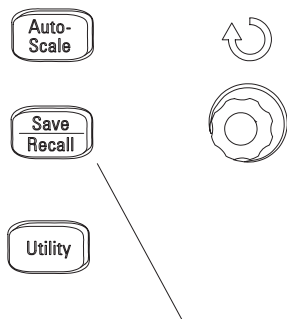

Figure 46 Save/Recall Button

To save and load waveforms

You can save/load oscilloscope waveforms to/from 10 internal, nonvolatile memory locations.

- 1 Press **Save/Recall**.
- 2 In the Save/Recall menu, select **Storage** until “Waveforms” is selected.
- 3 Press **Waveform** to select the desired internal memory location.
- 4 Press **Save** or **Load**.

To save and load oscilloscope setups

You can save/load oscilloscope setups to/from 10 internal, nonvolatile memory locations.

- 1 Press **Save/Recall**.
- 2 In the Save/Recall menu, select **Storage** until “Setups” is selected.
- 3 Press **Setup** to select the desired internal memory location.
- 4 Press **Save** or **Load**.

Saving to and Recalling from a USB Mass Storage Device

If the oscilloscope has the USB host port module attached to the rear panel, you can attach a USB mass storage device and:

- Save and recall waveforms and setups.
- Save screen images to BMP format files.
- Save data to CSV format files.

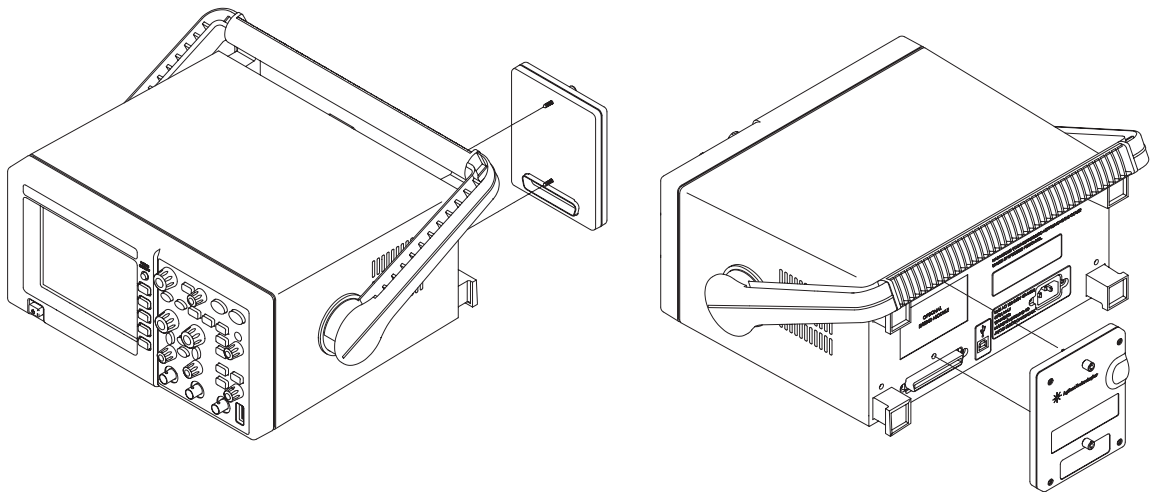

Figure 47 USB Module on Rear Panel

To save/load waveforms to/from a USB device

You can save/load waveforms to an external USB drive when it is connected to the USB host port.

- 1 Press **Save/Recall**.
- 2 In the Save/Recall menu, press **Storage** until “USB” is selected.
- 3 Press **File Type** until “Waveform” is selected.
- 4 Press **Save** or **Load**.

For information on using the Save menu, see [“To save a file to a USB device”](#) on page 106.

For information on using the Load menu, see [“To load a file from a USB device”](#) on page 108.

To save/load oscilloscope setups to/from a USB device

You can save/load setups to an external USB drive when it is connected to the USB host port.

- 1 Press **Save/Recall**.
- 2 In the Save/Recall menu, press **Storage** until “USB” is selected.
- 3 Press **File Type** until “Setup” is selected.
- 4 Press **Save** or **Load**.

For information on using the Save menu, see [“To save a file to a USB device”](#) on page 106.

For information on using the Load menu, see [“To load a file from a USB device”](#) on page 108.

To save screens to BMP format files (on a USB device)

You can save oscilloscope display screens (in BMP format) to an external USB drive when it is connected to the USB host port.

- 1 Press **Save/Recall**.
- 2 In the Save/Recall menu, press **Storage** until “USB” is selected.
- 3 Press **File Type** until “Bit map” is selected.
- 4 Press **Bmp Format** to select between 24-bit and 8-bit.
- 5 Press **Save**.

For information on using the Save menu, see [“To save a file to a USB device”](#) on page 106.

To save data to CSV format files (on a USB device)

You can save captured data in CSV (comma-separated value) format to an external USB drive when it is connected to the USB host port.

- 1 Press **Save/Recall**.
- 2 In the Save/Recall menu, press **Storage** until “USB” is selected.
- 3 Press **File Type** until “CSV” is selected.
- 4 Press **Save**.

For information on using the Save menu, see “[To save a file to a USB device](#)” on page 106.

To save a file to a USB device

When saving a waveform, setup, screen BMP, or data CSV file to a USB device, the Save menu is used to locate and name the file.



Figure 48 USB Device Save Menu

In the Save menu:

- To select the folder in which you want to save the file, press **Location** and turn the **Entry** knob; when you have selected the desired folder, press **Location** again.
- To highlight a character in the file name, press **Enter** to rotate through the characters from left to right.
- To add a character to the file name, press **Enter** until there is a highlighted box at the end of the file name; then, turn the **Entry** knob to select the new character.
- To change the value of the highlighted character in a file name, press **File Name** and turn the **Entry** knob; when the desired character has been selected, press **Enter**.
- To delete the highlighted character from the file name, press **Delete Character**.
- Once you have entered the name, press **Save** to save the file.
- If the file name already exists, the Over Write menu lets you confirm or cancel the save.

Connect the USB device to a computer to perform other file and folder operations (for example, creating folders, deleting files, etc.).

To load a file from a USB device

When loading a waveform or setup file from a USB device, the Load menu is used to select the file.



Figure 49 USB Device Load Menu

In the Load menu:

- To select files or folders, press **File Name** and turn the **Entry** knob.
- To navigate into a selected folder, press **File Name**.
- When the desired file is selected, press **Load** to load the file.

Printing the Display to a USB Printer

You need a USB cable to connect the printer to the oscilloscope.

- 1 Connect the printer to the USB host port on the rear of the oscilloscope.

Take note that the USB host ports are rectangular and USB device port is square.

- 2 To access the Print Setup menu, press **Utility**, then **1/2** softkey, followed by **Print Setup** softkey.

Note that the **Print Setup** softkey is located at page 2 of the Utility main menu.

The **Print Setup** softkey will be enabled only if the USB printer has been connected to the oscilloscope.

The available options at Print Set menu are **Print**, **Inverted**, and **Palette**.

- 3 Select your preferred **Inverted** option:
 - ON – This option changes the black background of display image to white. This can be used to reduce the amount of black ink it takes to print oscilloscope display images.
 - OFF – This option prints the display image as shown on the screen.
- 4 Select your preferred **Palette** option:
 - Grayscale – When this option is selected, the traces are printed in shades of gray rather than in color.
 - Color – When this option is selected, the traces are printed in color.
- 5 Press the **Print** softkey.

Supported Printers

HP DeskJet and LaserJet printers are supported. The following printers have been tested:

- HP Deskjet 9868
- HP Business Inkjet 1000
- HP Photosmart 7458
- HP LaserJet 1160
- HP LaserJet 3015
- HP LaserJet 3020
- HP LaserJet 5550
- HP LaserJet 1320
- HP All in One 5510A
- HP DeskJet 935A
- HP Photosmart 7760
- HP All In One 7410
- HP DeskJet 970CXI
- HP DeskJet 895CXI
- HP DeskJet 925C
- HP DeskJet 1200C

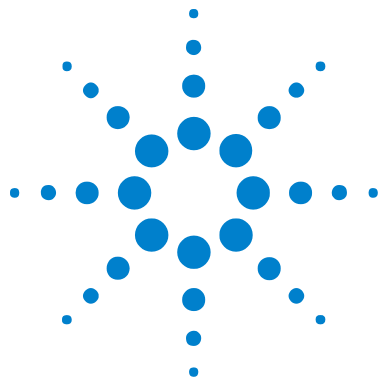

6 Oscilloscope Utility Settings

- Performing Mask Tests 112
- Setting IO Parameters 115
- Setting the Menu Language 115
- Turning Sound ON or OFF 116
- Displaying System Information 116
- Performing Self-Tests 117
- Running Self-Calibration 118

This chapter describes oscilloscope settings found in the Utilities menu.

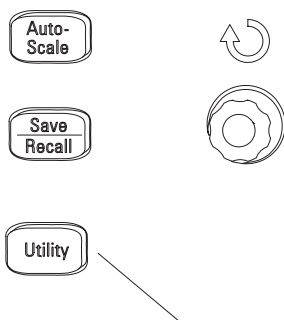

Figure 50 Utility Button



Performing Mask Tests

The mask test function monitors waveform changes by comparing the waveform to a predefined mask.

NOTE

The Mask Test function is not available in the X-Y horizontal timebase mode.

To access the Mask Test menu:

- 1 Press **Utility**.
- 2 In the Utilities menu, select **Mask Test**.



To enable/disable mask tests

- 1 In the Mask Test menu (**Utility**→**Mask Test**), select **Enable Test** to toggle between OFF and ON.

To select the source channel for mask tests

- 1 In the Mask Test menu (**Utility**→**Mask Test**), press **Source** to select the desired input channel.

To run/stop a mask test

- 1 In the Mask Test menu (**Utility**→**Mask Test**), select **Operate** to run or stop the test.
 -  – Appears on the menu when the test is stopped; press **Operate** to run the test.
 -  – Appears on the menu when the test is running; press **Operate** to stop the test.

To turn on/off the mask test message display

- 1 In the Mask Test menu (**Utility**→**Mask Test**), select **Msg Display** to toggle between OFF and ON.

The message display shows the failed, passed, and total number of waveforms.

To set the mask test output condition

- 1 In the Mask Test menu (**Utility**→**Mask Test**), select **Output**.
- 2 Continue pressing the menu button to select the desired output condition:
 - Fail – A mask failure sets the output.
 - Pass – A passing waveform sets the output.

The output condition can be used to stop a running mask test or as a source for the waveform recording function (see [“Recording/Playing-back Waveforms”](#) on page 83).

To stop a mask test on the output condition

To turn on/off stopping the mask test when the output condition occurs:

- 1 In the Mask Test menu (**Utility**→**Mask Test**), select **Stop On Output** to toggle between OFF and ON.

To set up masks

You can create masks by adding horizontal and vertical margins to a signal. You can save and load masks from internal memory.

To adjust a mask's horizontal failure margin

- 1 In the Mask menu (**Utility**→**Mask Test**), select **X Mask**.
- 2 Turn the **Entry** knob to adjust the horizontal failure margin.

The margin can be set from 0.04 div to 4.00 div.

To adjust a mask's vertical failure margin

- 1 In the Mask menu (**Utility**→**Mask Test**), select **Y Mask**.
- 2 Turn the **Entry** knob to adjust the vertical failure margin.

The margin can be set from 0.04 div to 4.00 div.

To create a mask using the failure margin settings

- 1 In the Mask menu (**Utility**→**Mask Test**), select **Create Mask**.

To save a mask

- 1 In the Mask menu (**Utility**→**Mask Test**), select **Save**.

To load a mask

- 1 In the Mask menu (**Utility**→**Mask Test**), select **Load**.

Setting IO Parameters

When programming the oscilloscope over the RS-232 interface, the baud rate must match on the oscilloscope and the controller PC's RS-232 port.

To set the RS-232 interface baud rate:

- 1 Press **Utility**.
- 2 In the Utilities menu, select **IO Setup**.
- 3 In the I/O Setup menu, press **RS-232 Baud** to select the desired baud rate.

For more on programming the oscilloscope, see the *3000 Series Oscilloscopes Programmer's Guide*.

Setting the Menu Language

To set the language used in menus:



- 1 Press **Utility**.
- 2 In the Utilities menu, press **Language** to select the desired menu language.

You can select from the following languages:

- Simplified Chinese.
- Traditional Chinese.
- Korean.
- Japanese.
- English.
- German.
- French.
- Portuguese.
- Spanish.
- Italian.
- Russian.

Turning Sound ON or OFF

To turn the oscilloscope's beeper sound on or off:

- 1 Press **Utility**.
- 2 In the Utilities menu, select **Sound** to toggle between:
 -  – on.
 -  – off.

Displaying System Information

To display the oscilloscope's system information:

- 1 Press **Utility**.
- 2 In the Utilities menu, press **System Info**.

The system information contains:

- Model number.
- Power up times.
- Serial number.
- Software version.
- Installed module information.

To exit, press **Run/Stop**.

Performing Self-Tests

The oscilloscope's Self-Test menu lets you perform screen and key tests.

To access the Self-Test menu:

- 1 Press **Utility**.
- 2 In the Utilities menu, select **Self-Test**.

To perform screen tests

To run the screen test:

- 1 In the Self-Test menu (**Utility**→**Self-Test**), select **Screen Test**.

Follow the on-screen message. The screen of the oscilloscope turns black, white, red, green, and blue in sequence when pressing the **Run/Stop** front panel key. Check the screen for display failures.

To exit the screen test, press **Run/Stop**.

To perform key tests

To run the front panel keys and knobs test:

- 1 In the Self-Test menu (**Utility**→**Self-Test**), select **Key Test**.

The on screen rectangles represent the front panel keys. The rectangles with two arrows beside them represent the front panel knobs. The squares represent the knob presses for knobs like the Scale knobs.

Test all keys and knobs and verify that all of the controls turn green.

To exit the key test, press **Run/Stop** three times.

Running Self-Calibration

The automatic calibration routine adjusts the internal circuitry of the oscilloscope for the best measurement accuracy.

The automatic calibration should be run when the ambient temperature changes by 5 °C or more.

NOTE

Before performing the automatic calibration, let the oscilloscope warm-up at least 30 minutes.

To run the oscilloscope's self-calibration:

- 1 Press **Utility**.
- 2 In the Utilities menu, select **Self-Cal**.
- 3 Follow the instructions on the Calibration screen.

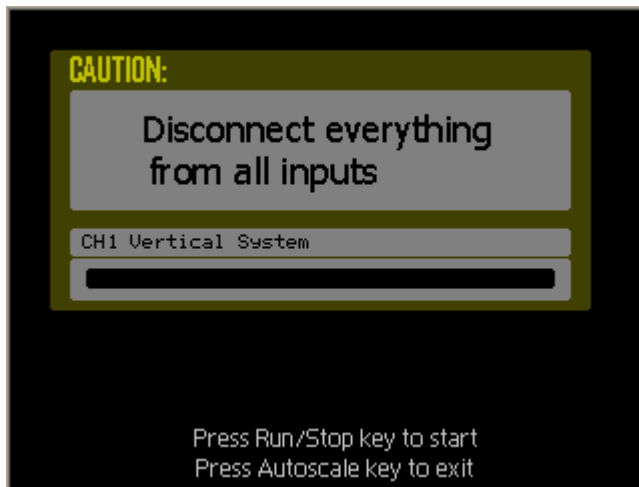
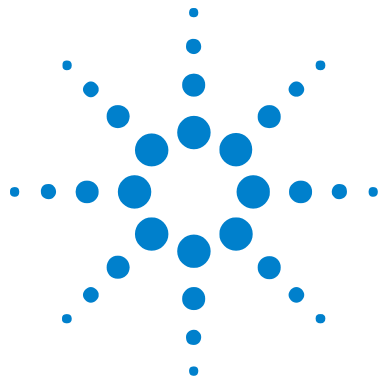

Figure 51 Calibration Screen



7 Specifications and Characteristics

Specifications	120
Characteristics	121

This chapter describes the 3000 Series oscilloscopes' specifications and characteristics.



Specifications

NOTE

All specifications are warranted. Specifications are valid after a 30-minute warm-up period and ± 5 °C from last calibration temperature.

Table 4 Specifications

Name	Value
Bandwidth (-3 dB):	DSO3062A: 60 MHz
	DSO3102A: 100 MHz
	DSO3152A: 150 MHz
	DSO3202A: 200 MHz
DC vertical gain accuracy:	2 mV/div to 5 mV/d: $\pm 4.0\%$ full scale
	10 mV/div to 5 V/div: $\pm 3.0\%$ full scale

Characteristics

NOTE

All characteristics are the typical performance values and are not warranted. Characteristics are valid after a 30-minute warm-up period and ± 5 °C from last calibration temperature.

Table 5 Acquisition System Characteristics

Name	Typical Value
Max sample rate:	1 GSa/s
Vertical resolution:	8 bits
Peak detection:	5 ns
Averages:	Selectable from 2, 4, 8, 16, 32, 64, 128, or 256

Table 6 Vertical System Characteristics

Name	Typical Value
Analog channels:	Channels 1 and 2 simultaneous acquisition DS03062A: 60 MHz DS03102A: 100 MHz DS03152A: 150 MHz DS03202A: 200 MHz
Calculated rise time (= 0.35/bandwidth):	DS03202A: 1.8 ns DS03152A: 2.3 ns DS03102A: 3.5 ns DS03062A: 5.8 ns
Range:	2 mV/div to 5 V/div
Maximum Input:	CAT II 1 M Ω 300 Vrms
	
Offset Range:	± 2 V 2 mV/div to 100 mV/div ± 40 V on ranges 102 mV/div to 5 V/div

7 Specifications and Characteristics

Table 6 Vertical System Characteristics (continued)

Name	Typical Value
Dynamic range:	±6 div
Input resistance:	1 MΩ ± 1%
Input capacitance:	~13 pF
Coupling:	AC, DC, ground
BW limit:	~20 MHz
ESD tolerance:	±2 kV
DC vertical gain accuracy:	2 mV/div to 5 mV/div: ±4% 10 mV/div to 5 V/div ±3%
DC measurement (= 16 waveform averages)	±(3% x reading + 0.1 div + 1 mV) when 10 mV/div or greater is selected and vertical position is at zero ±(3% x (reading + vertical position) + 1% of vertical position + 0.2 div) when 10 mV/div or greater is selected and vertical position is not at zero Add 2 mV for settings from 2 mV/div to 200 mV/div Add 50 mV for settings > 200 mV/div to 5 V/div

Table 7 Horizontal System Characteristics

Name	Typical Value
Range:	2 ns/div to 50 s/div
Timebase accuracy:	±100 ppm over any time interval = 1 ms
Modes:	Main, Delayed, Y-T, X-Y

Table 8 Trigger System Characteristics

Name	Typical Value
Sources:	Channel 1, channel 2, ac line, ext, and ext/5
Sweep:	Auto and Normal
Holdoff time:	100 ns to 1.5 s

Table 8 Trigger System Characteristics (continued)

Name	Typical Value
Selections:	
• Edge	Trigger on a rising or falling edge of any source
• Pulse Width	Trigger when a positive-going or negative-going pulse is less than, greater than, or equal to a specified value on any of the source channels Range: 20 ns to 10 s
• Video	Trigger on any analog channel for NTSC, PAL, or SECAM broadcast standards on either positive or negative composite video signals. Modes supported include Even Field, Odd Field, all lines, or any line within a field.
Maximum Input:	CAT II 300 Vrms
	
Trigger level range:	
• Internal	± 12 divisions from center screen
• EXT	± 2.4 V
• EXT/5	± 12 V
Sensitivity:	
• DC	CH1, CH2: 1 div (DC to 10 MHz), 1.5 div (10 MHz to full bandwidth) EXT: 100 mV (DC to 10 MHz), 200 mV (10 MHz to full bandwidth) EXT/5: 500 mV (DC to 10 MHz), 1 V (10 MHz to full bandwidth)
• AC	Same as DC at 50 Hz and above
• LF Reject	Same as DC limits for frequencies above 100 kHz. Waveforms below 8 kHz are attenuated
• HF Reject	Same as DC limits for frequencies from DC to 10 kHz. Frequencies above 150 kHz are attenuated

Table 9 Display System Characteristics

Name	Typical Value
Display:	5.7-inch (145 mm) diagonal liquid crystal display
Resolution:	240 vertical by 320 horizontal pixels
Display brightness:	Adjustable

Table 10 Measurement Features

Name	Typical Value
Automatic measurements:	
• Voltage:	Peak-to-Peak (Vpp), Maximum (Vmax), Minimum (Vmin), Average (Vavg), Amplitude (Vamp), Top (Vtop), Base (Vbase), Overshoot, Preshoot, RMS (Vrms)
• Time:	Frequency (Freq), Period, Positive Pulse Width (+Width), Negative Pulse Width (-Width), Positive Duty Cycle (+Duty), Minus Duty Cycle (-Duty), Rise Time, Fall Time, Rising Edge Time Delay from Channel 1 to Channel 2 (Delay1→2 \uparrow), Falling Edge Time Delay from Channel 1 to Channel 2 (Delay1→2 \downarrow), Hardware Counter

Table 11 General Characteristics

Name	Typical Value
Physical size:	350 mm wide x 288 mm high x 145 mm deep (without handle)
Weight:	4.8 kgs
Calibrator output:	Frequency 1 kHz; Amplitude 3 Vpp into 1 M Ω load

Table 12 Power Requirements

Name	Typical Value
Line voltage:	Range 100 to 240 VAC $\pm 10\%$, CAT II, automatic selection
Line frequency:	50 to 440 Hz
Power usage:	50 VA max

Table 13 Environmental Characteristics

Name	Typical Value
Ambient temperature:	Operating 0° C to +55° C Non-operating -40° C to +70° C
Humidity:	Operating: 95% RH at 40° C for 24 hour Non-operating 90% RH at 65° C for 24 hour
Altitude:	Operating to 4,570 m (15,000 ft) Non-operating to 15,244 m (50,000 ft)
Vibration:	Agilent class B1
Shock:	Agilent class B1
Pollution degree:	Normally only dry non-conductive pollution occurs. Occasionally a temporary conductivity caused by condensation must be expected.
Indoor use:	Rated for indoor use only.

Table 14 Other

Name	Typical Value
Installation categories:	CAT I: Mains isolated CAT II: Line voltage in appliance and to wall outlet

7 Specifications and Characteristics

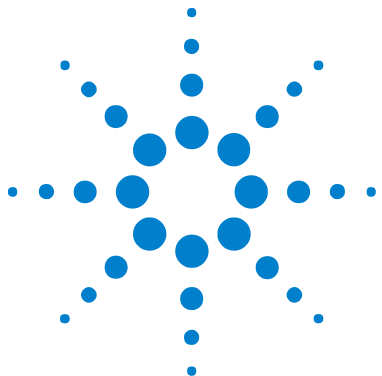

8 Service

Testing Performance	128
Vertical Performance Verification	130
Performance Test Record	144
Returning the Oscilloscope to Agilent for Service	146
Contacting Agilent	146

This chapter describes oscilloscope maintenance, performance testing, and what to do if your oscilloscope requires service.



Testing Performance

This section documents performance test procedures. Performance verification for the products covered by this manual consists of three main steps:

- Performing the internal product self-tests to ensure that the measurement system is functioning properly.
- Calibrating the product.
- Testing the product to ensure that it is performing to specification.

Performance Test Interval

The procedures in this section may be performed for incoming inspection and should be performed periodically to verify that the oscilloscope is operating within specification. The recommended test interval is once per year or after 2000 hours of operation. Performance should also be tested after repairs or major upgrades.

Performance Test Record

A test record form is provided on [page 144](#). This record lists performance tests, test limits and provides space to record test results.

Test Order

The tests in this section may be performed in any order desired. However, it is recommended to conduct the tests in the order presented in this manual as this represents an incremental approach to performance verification. This may be useful if you are attempting to troubleshoot a suspected problem.

Test Equipment

Lists of equipment needed to conduct each test are provided for each test procedure. The procedures are written to minimize the number and types of oscilloscopes and accessories required. The oscilloscopes in these lists are ones that are currently available for sale by Agilent at the time of writing this document. In some cases, the test procedures use features specific to the oscilloscopes in the recommended equipment list. However, with some modification to the test procedures, oscilloscopes, cables and accessories that satisfy the critical specifications in these lists may be substituted for the recommended models with some modification to the test procedures.

Contact Agilent Technologies (see [page 146](#)) for more information about the Agilent products in these lists.

Before Testing Performance

NOTE

Let the oscilloscope warm up before testing.

The oscilloscope under test must be warmed up (with the oscilloscope application running) for at least 30 minutes prior to the start of any performance test.

Equipment Required

Table 15 Equipment Required for Performance Verification Testing

Description	Critical Specifications	Recommended Model/Part Numbers
Digital Multimeter	DC voltage measurement accuracy better than $\pm 0.1\%$ of reading	Agilent 34401A
Cable Assembly	50 Ω characteristic impedance	Agilent 54855-61620
Cable Assembly	RS-232 (f)(f)	Agilent 34398A
Adapter	BNC Barrel (f)(f)	Agilent 1250-0080
Adapter	BNC shorting cap	Agilent 1250-0929
Adapter	Precision BNC (2)	Agilent 54855-67604
Adapter	BNC (f) to dual banana	Agilent 1251-2277

Calibration

- 1 Push the **Utility** button on the front panel.
- 2 Select **Self-Cal** menu item in the Utility menu.
- 3 Follow the on-screen instructions.

Vertical Performance Verification

This section contains the following vertical performance verification:

- DC Gain Accuracy Test.
- Analog Bandwidth Test.

DC Gain Accuracy Test

CAUTION

Ensure that the input voltage to the oscilloscope never exceeds 300 Vrms.

Specifications

Table 16 DC Gain Accuracy Specification

DC Gain Accuracy	2 mV/div to 5 mV/d: $\pm 4.0\%$ full scale 10 mV/div to 5 V/div: $\pm 3.0\%$ full scale
------------------	--

Full scale is defined as 8 vertical divisions. The major scale settings are 2 mV, 5 mV, 10 mV, 20 mV, 50 mV, 100 mV, 200 mV, 500 mV, 1 V, 2 V, and 5 V.

Equipment Required

Table 17 Equipment Required for DC Gain Accuracy Test

Description	Critical Specifications	Recommended Model/Part Numbers
Power Supply	0 V to 35 V DC; 10 mV resolution	Agilent E3633A or E3634A
Digital Multimeter	DC voltage measurement accuracy better than $\pm 0.1\%$ of reading	Agilent 34401A

Table 17 Equipment Required for DC Gain Accuracy Test (continued)

Description	Critical Specifications	Recommended Model/Part Numbers
Cable Assembly (2 required)	50 Ω characteristic impedance, BNC (m) connectors	Agilent 8120-1840
Adapter	BNC Tee (m)(f)(f)	Agilent 1250-0781
Adapter (2 required)	BNC (f) to dual banana	Agilent 1251-2277

Procedure

- 1 Disconnect all cables from the oscilloscope channel inputs.
- 2 Press **Save/Recall**.
- 3 Select the **Storage** item in the Save/Recall menu until Setups appears.

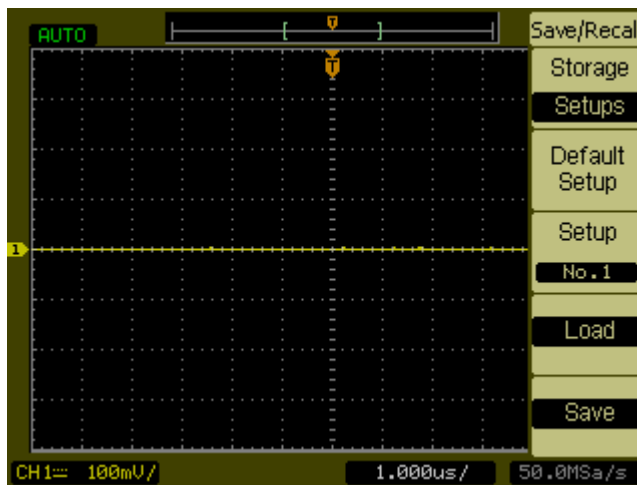
**Figure 52** Default Setup Menu Item

- 4 Select the **Default Setup** item in the Save/Recall menu.
- 5 Press the **Acquire** front panel button.
- 6 Select the **Mode** item in the Acquire menu until “Average” appears.

7 Select the **Averages** item in the Acquire menu until “256” appears.

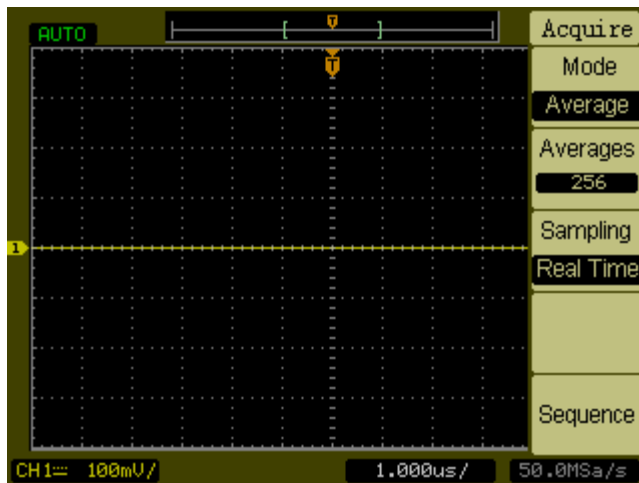

Figure 53 Averages Menu Item

8 Set the channel 1 vertical sensitivity value to 2 mV/div.

9 Set the power supply to +6 mV.

10 Connect the equipment as shown in [Figure 54](#).

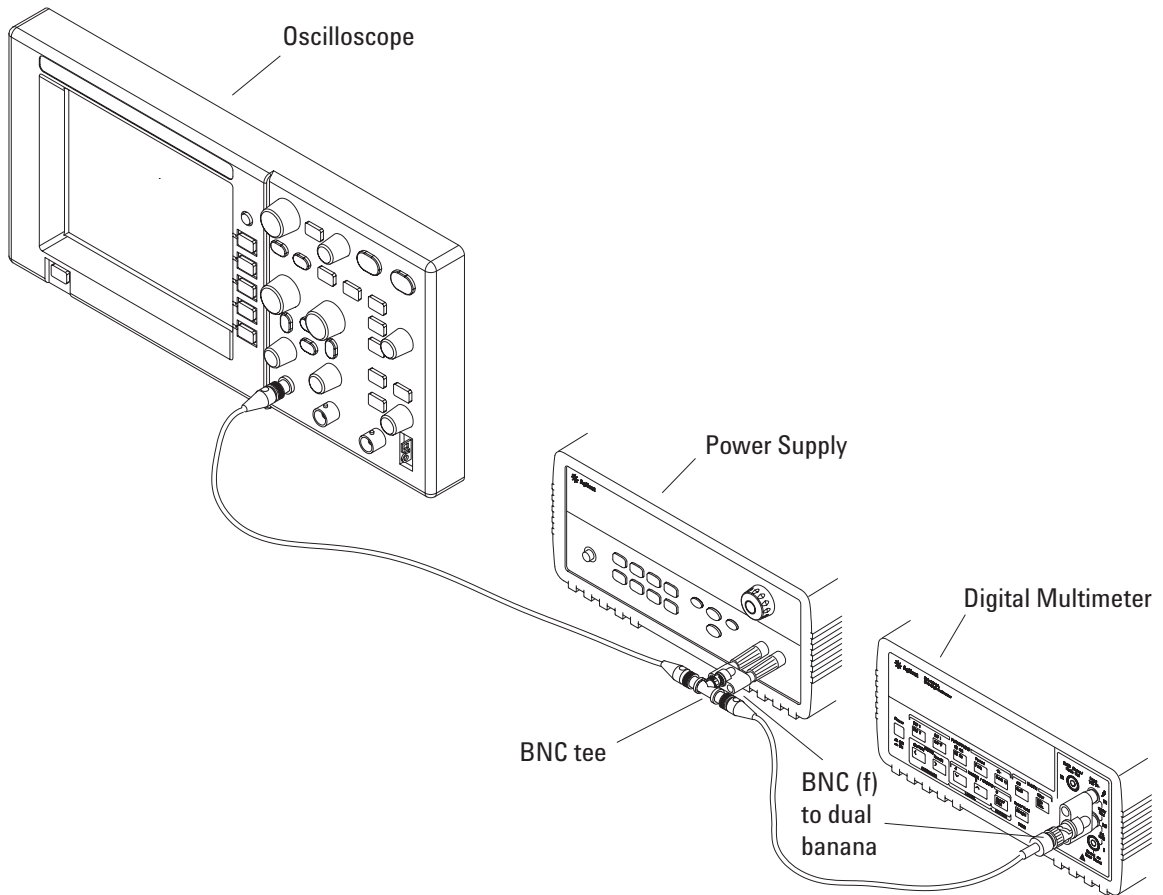

Figure 54 Connecting Equipment for DC Gain Accuracy Test

- 11 Press **Measure**.
- 12 Select the **Voltage** menu item.
- 13 Select the **Vavg** measurement as shown below.

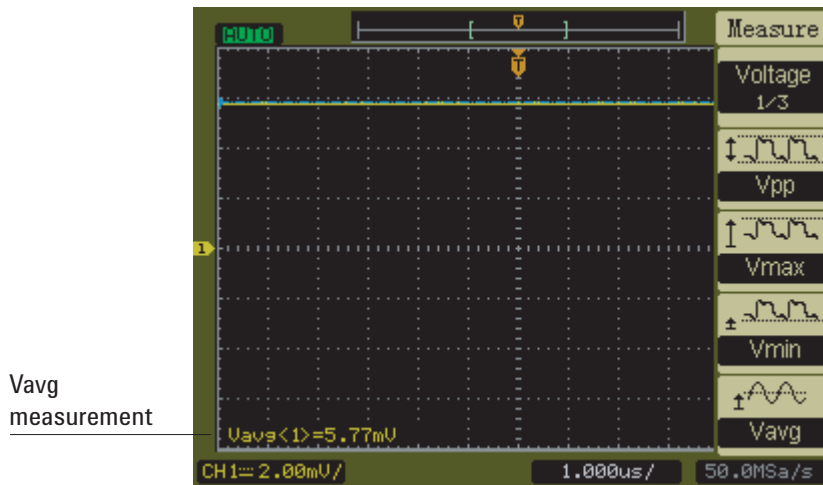

Figure 55 Vavg Menu Item

- 14** For each channel 1 vertical sensitivity in the DC Gain Test section of the “Performance Test Record” on page 144:
- a** For the positive (+) power supply setting:
 - i** Record the DMM voltage reading as V_{DMM+} .
 - ii** Record the oscilloscope Vavg reading as V_{Scope+} .
 - b** For the negative (-) power supply setting:
 - i** Record the DMM voltage reading as V_{DMM-} .
 - ii** Record the oscilloscope Vavg reading as V_{Scope-} .
 - c** Calculate the DC Gain using the following expression and record this value in the DC Gain Test section of the Performance Test Record:

$$DCGain = \frac{\Delta V_{out}}{\Delta V_{in}} = \frac{V_{scope+} - V_{scope-}}{V_{DMM+} - V_{DMM-}}$$

- 15** Set the power supply voltage to +6 mV.
- 16** Move the BNC cable on channel 1 to channel 2.
- 17** Press **Save/Recall**.
- 18** Select the **Storage** item in the Save/Recall menu until “Setups” appears.

- 19 Select **Default Setup** in the Save/Recall menu.
- 20 Set the channel 2 vertical sensitivity value to 2 mV/div.
- 21 Press **Measure**.
- 22 Select the **Voltage** menu item.
- 23 Select the **Vavg** measurement.
- 24 For each channel 2 vertical sensitivity in the DC Gain Test section of the “[Performance Test Record](#)” on page 144:
 - a For the positive (+) power supply setting:
 - i Record the DMM voltage reading as V_{DMM+} .
 - ii Record the oscilloscope Vavg reading as V_{Scope+} .
 - b For the negative (-) power supply setting:
 - i Record the DMM voltage reading as V_{DMM-} .
 - ii Record the oscilloscope Vavg reading as V_{Scope-} .
 - c Calculate the DC Gain using the following expression and record this value in the DC Gain Test section of the Performance Test Record:

$$DCGain = \frac{\Delta V_{out}}{\Delta V_{in}} = \frac{V_{scope+} - V_{scope-}}{V_{DMM+} - V_{DMM-}}$$

Analog Bandwidth - Maximum Frequency Check

CAUTION

Ensure that the input voltage to the oscilloscope never exceeds 300 Vrms.

Specification

Table 18 DC Gain Accuracy Specification

Analog Bandwidth (-3 dB)	
DSO3062A	60 MHz
DSO3102A	100 MHz
DSO3152A	150 MHz
DSO3202A	200 MHz

Equipment Required

Table 19 Equipment Required for Performance Verification Testing

Description	Critical Specifications	Recommended Model/Part Numbers
Signal Generator	100 kHz to 1 GHz at 200 mVrms	Agilent 8648A
Power Splitter	outputs differ by < 0.15 dB	Agilent 11667B
Power Meter	Agilent E-series with power sensor compatibility	Agilent E4418B
Power Sensor	100 kHz to 1 GHz \pm 3% accuracy	Agilent 8482A
SMA Cable	SMA (m) to SMA (m) 24 inch	
Adapter	50 Ω BNC feed through terminator	
Adapter	Type N (m) to SMA (f)	Agilent 1250-1250
Adapter	Type SMA (m) to BNC (m)	Agilent 1250-0831

Connections

Connect the equipment as shown in [Figure 56](#).

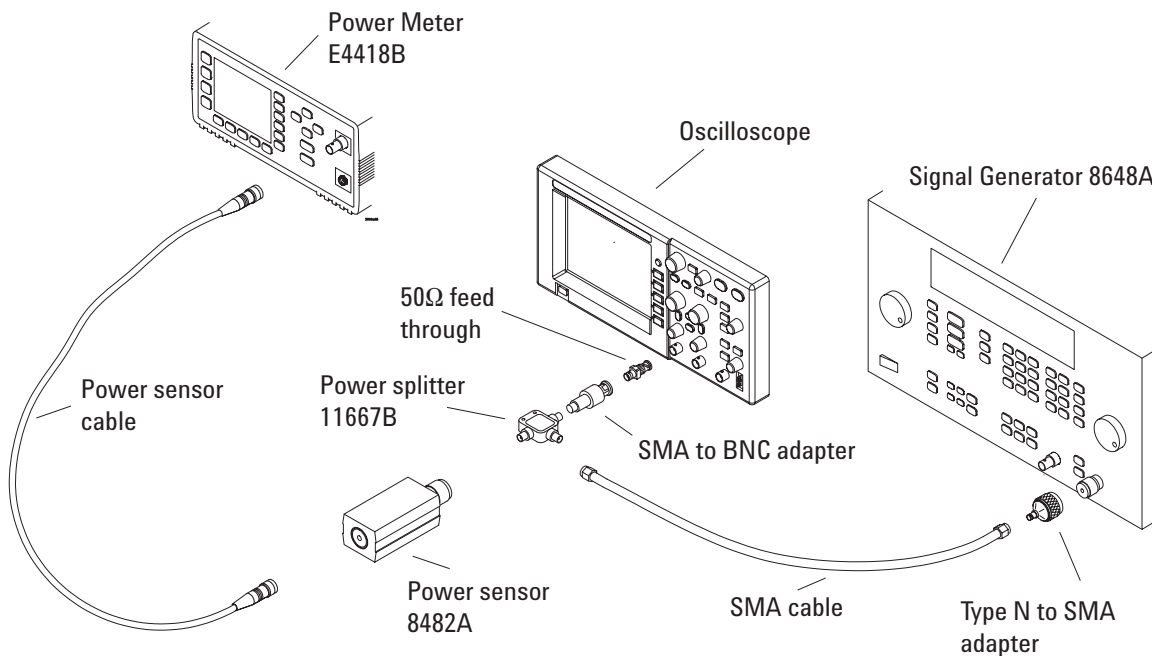

Figure 56 Connecting Equipment for Maximum Frequency Check Test

Procedure

- 1 Preset and calibrate the power meter according to the instructions found in the power meter manual.
- 2 Set up the Power Meter to display measurements in units of Watts.
- 3 On the oscilloscope, press **Save/Recall**.
- 4 Select the **Storage** item in the Save/Recall menu until “Setups” appears.

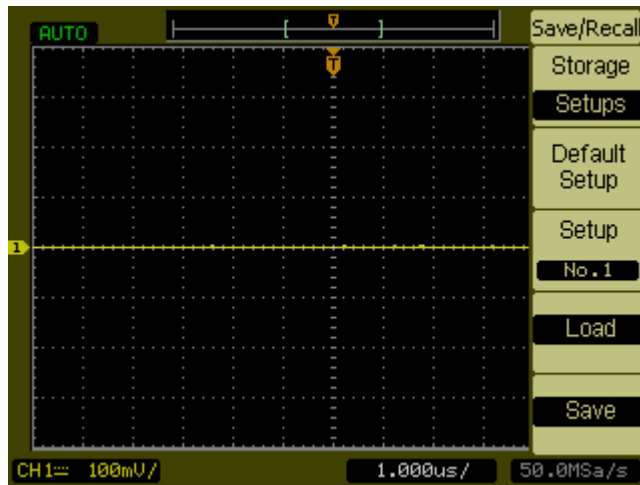

Figure 57 Default Setup Menu Item

- 5 Select the **Default Setup** item in the Save/Recall menu.
- 6 Press the **Auto-Scale** front panel button.
- 7 Set the channel 1 vertical scale to 200 mV/div.

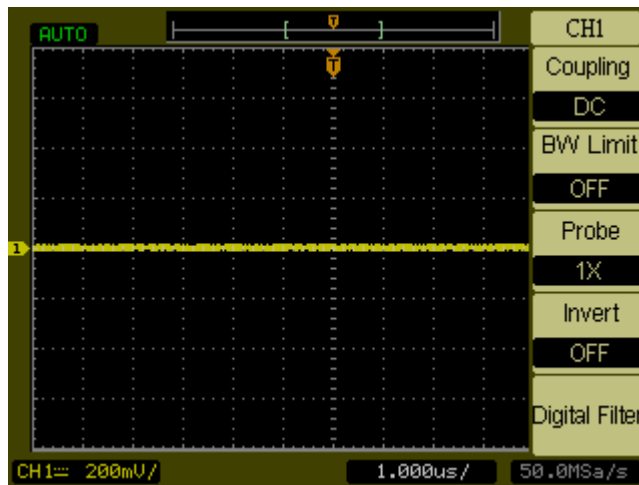

Figure 58 Channel 1 Vertical Scale Setting

8 Set the horizontal scale to 500 ns/div.

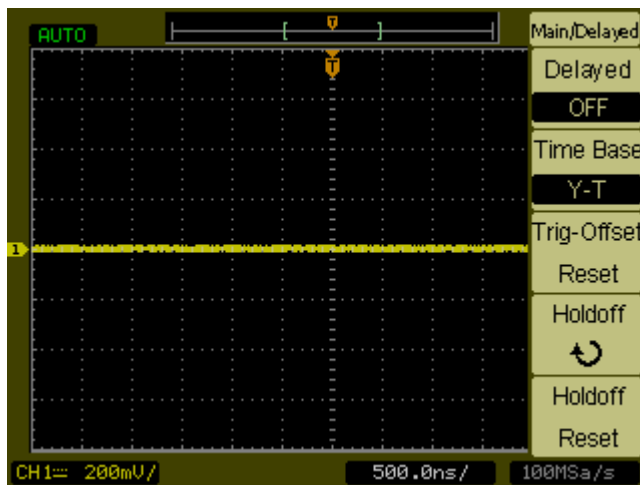

Figure 59 Channel 1 Horizontal Scale Setting

- 9 Press **Acquire**.
- 10 Select the **Mode** menu item until “Average” appears.
- 11 Select the **Average** menu item until “8” appears.

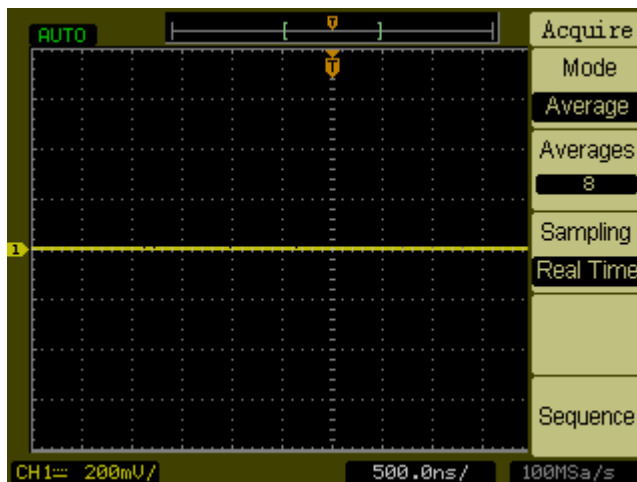

Figure 60 Averages Menu Item

- 12 Press **Measure**.
- 13 Select the **Voltage** menu item.
- 14 Select the **Vpp** menu item.
- 15 Set the signal generator to a 1 MHz sine wave with a peak-to-peak amplitude of about 6 divisions as it appears on the oscilloscope screen.

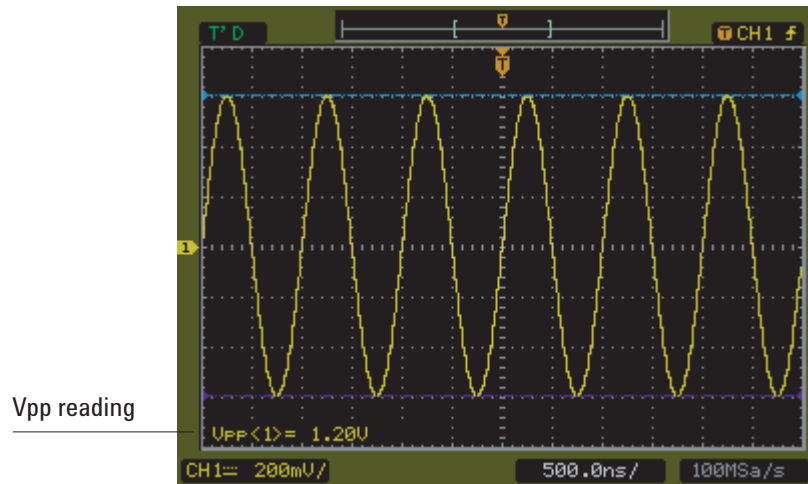

Figure 61 Signal Generator Waveform

- 16** Using the V_{pp} reading, calculate the V_{rms} value using the following expression and record it in the “Performance Test Record” on page 144:

$$V_{out_{1MHz}} = \frac{V_{PP_{1MHz}}}{2\sqrt{2}}$$

For example, if $V_{pp} = 1.20$ V:

$$V_{out_{1MHz}} = \frac{1.20}{2\sqrt{2}} = \frac{1.20}{2.828} = 424 \text{ mV}$$

- 17** Using the power meter reading, convert this measurement to Volts RMS using the expression and record it in the “Performance Test Record” on page 144:

$$V_{in_{1MHz}} = \sqrt{P_{meas} \times 50\Omega}$$

For example, if $P_{meas} = 3.65$ mW:

$$V_{in_{1MHz}} = \sqrt{3.65 \text{ mW} \times 50\Omega} = 427 \text{ mV}$$

18 Calculate the reference gain as follows:

$$Gain_{1MHz} = \frac{V_{out_{1MHz}}}{V_{in_{1MHz}}}$$

Record this value in the Calculated Gain @ 1 MHz column of the “Performance Test Record” on page 144.

19 Change the signal generator frequency to the value for the model being tested as shown in the table below.

Table 20 Oscilloscope Models and Signal Generator Frequency

Setting	Model			
	DS03062A	DS03102A	DS03152A	DS03202A
Frequency	60 MHz	100 MHz	150 MHz	200 MHz
Time Base	10 ns/div	5 ns/div	5 ns/div	2 ns/div

20 Change the oscilloscope time base to the value for the model being tests as shown in the table above.

21 Using the V_{pp} reading, calculate the V_{rms} value using the following expression and record it in the “Performance Test Record” on page 144:

$$V_{out_{max}} = \frac{V_{PP_{max}}}{2\sqrt{2}}$$

For example, if $V_{pp} = 1.24$ V:

$$V_{out_{max}} = \frac{1.05}{2\sqrt{2}} = \frac{1.05}{2.828} = 371 \text{ mV}$$

22 Using the power meter reading, convert this measurement to Volts RMS using the expression and record it in the “Performance Test Record” on page 144:

$$V_{in_{max}} = \sqrt{P_{meas} \times 50\Omega}$$

For example, if $P_{meas} = 3.65$ mW:

$$V_{in_{max}} = \sqrt{3.65 \text{ mW} \times 50\Omega} = 427 \text{ mV}$$

- 23** Calculate the gain at the maximum frequency using the expression and record it in the “Performance Test Record” on page 144:

$$Gain_{max} = 20 \log_{10} \left[\frac{(V_{out_{max}})/(V_{in_{max}})}{Gain_{1MHz}} \right]$$

For example, if (Vout @ Max Frequency) = 371 mV, (Vin @ Max Frequency) = 427 mV and Gain @ 1 MHz = 0.993, then:

$$Gain_{Max \text{ Freq}} = 20 \log_{10} \left[\frac{371 \text{ mV}/427 \text{ mV}}{0.993} \right] = -1.16 \text{ dB}$$

Record this value in the Calculated Gain @Max Freq column in the Analog Bandwidth - Maximum Frequency Check section of the “Performance Test Record” on page 144. To pass this test, this value must be greater than -3.0 dB.

- 24** Move the power splitter from channel 1 to channel 2 and repeat steps 3 through 24 using channel 2 as the source.

Performance Test Record

Table 21 DC Gain Test

Vertical Sensitivity	Power Supply Setting	VDMM+	VDMM-	VScope+	VScope-	Calculated DC Gain	Offset Gain Test Limits
Channel 1							
2 mV/div	±6 mV						+0.96 to +1.04
5 mV/div	±15 mV						+0.96 to +1.04
10 mV/div	±30 mV						+0.97 to +1.03
20 mV/div	±60 mV						+0.97 to +1.03
50 mV/div	±150 mV						+0.97 to +1.03
100 mV/div	±300 mV						+0.97 to +1.03
200 mV/div	±600 mV						+0.97 to +1.03
500 mV/div	±1.5 V						+0.97 to +1.03
1 V/div	±2.4 V						+0.97 to +1.03
2 V/div	±6.0 V						+0.97 to +1.03
5 V/div	±15.0 V						+0.97 to +1.03

Table 21 DC Gain Test (continued)

Vertical Sensitivity	Power Supply Setting	VDMM+	VDMM-	VScope+	VScope-	Calculated DC Gain	Offset Gain Test Limits
Channel 2							
2 mV/div	±6 mV						+0.96 to +1.04
5 mV/div	±15 mV						+0.96 to +1.04
10 mV/div	±30 mV						+0.97 to +1.03
20 mV/div	±60 mV						+0.97 to +1.03
50 mV/div	±150 mV						+0.97 to +1.03
100 mV/div	±300 mV						+0.97 to +1.03
200 mV/div	±600 mV						+0.97 to +1.03
500 mV/div	±1.5 V						+0.97 to +1.03
1 V/div	±2.4 V						+0.97 to +1.03
2 V/div	±6.0 V						+0.97 to +1.03
5 V/div	±15.0 V						+0.97 to +1.03

Table 22 Analog Bandwidth - Maximum Frequency Check

	Vin @ 1 MHz	Vout @ 1 MHz	Calculated Gain @ 1 MHz (Test Limit = greater than -3 dB)	Vin @ Max Freq	Vout @ Max Freq	Calculated Gain @ Max Freq (Test Limit = greater than -3 dB)
Channel 1						
Channel 2						
Max frequency: DSO3062A = 60 MHz, DSO3102A = 100 MHz, DSO3152A = 150 MHz, DSO31202A = 200 MHz						

Returning the Oscilloscope to Agilent for Service

Before shipping the oscilloscope to Agilent Technologies, contact your nearest Agilent Technologies oscilloscope Support Center (or Agilent Technologies Service Center if outside the United States) for additional details.

- 1 Write the following information on a tag and attach it to the oscilloscope.
 - Name and address of owner.
 - Oscilloscope model number.
 - Oscilloscope serial number.
 - Description of the service required or failure indications.

- 2 Remove all accessories from the oscilloscope.

Accessories include all cables. Do not include accessories unless they are associated with the failure symptoms.

- 3 Protect the oscilloscope by wrapping it in plastic or heavy paper.

- 4 Pack the oscilloscope in foam or other shock absorbing material and place it in a strong shipping container.

You can use the original shipping materials or order materials from an Agilent Technologies Sales Office. If neither are available, place 8 to 10 cm (3 to 4 inches) of shock-absorbing material around the oscilloscope and place it in a box that does not allow movement during shipping.

- 5 Seal the shipping container securely.

- 6 Mark the shipping container as FRAGILE.

In any correspondence, refer to oscilloscope by model number and full serial number.

Contacting Agilent

Information on contacting Agilent Technologies can be found at www.agilent.com/find/contactus.

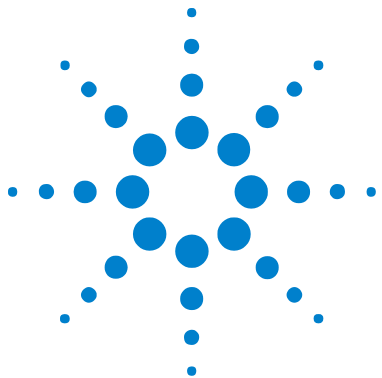

A Safety Notices

Warnings	147
To clean the instrument	148
Safety Symbols	149

This apparatus has been designed and tested in accordance with IEC Publication 1010, Safety Requirements for Measuring Apparatus, and has been supplied in a safe condition. This is a Safety Class I instrument (provided with terminal for protective earthing). Before applying power, verify that the correct safety precautions are taken (see the following warnings). In addition, note the external markings on the instrument that are described under "Safety Symbols."

Warnings

- Before turning on the instrument, you must connect the protective earth terminal of the instrument to the protective conductor of the (mains) power cord. The mains plug shall only be inserted in a socket outlet provided with a protective earth contact. You must not negate the protective action by using an extension cord (power cable) without a protective conductor (grounding). Grounding one conductor of a two-conductor outlet is not sufficient protection.
- Only fuses with the required rated current, voltage, and specified type (normal blow, time delay, etc.) should be used. Do not use repaired fuses or short-circuited fuse holders. To do so could cause a shock or fire hazard.
- If you energize this instrument by an auto transformer (for voltage reduction or mains isolation), the common terminal must be connected to the earth terminal of the power source.



- Whenever it is likely that the ground protection is impaired, you must make the instrument inoperative and secure it against any unintended operation.
- Service instructions are for trained service personnel. To avoid dangerous electric shock, do not perform any service unless qualified to do so. Do not attempt internal service or adjustment unless another person, capable of rendering first aid and resuscitation, is present.
- Do not install substitute parts or perform any unauthorized modification to the instrument.
- Capacitors inside the instrument may retain a charge even if the instrument is disconnected from its source of supply.
- Do not operate the instrument in the presence of flammable gasses or fumes. Operation of any electrical instrument in such an environment constitutes a definite safety hazard.
- Do not use the instrument in a manner not specified by the manufacturer.

To clean the instrument

If the instrument requires cleaning:

- 1 Remove power from the instrument.
- 2 Clean the external surfaces of the instrument with a soft cloth dampened with a mixture of mild detergent and water.

CAUTION

Do not use too much liquid in cleaning the oscilloscope. Water can enter the oscilloscope's front panel, damaging sensitive electronic components.

-
- 3 Make sure that the instrument is completely dry before reconnecting it to a power source.

Safety Symbols



Instruction manual symbol: the product is marked with this symbol when it is necessary for you to refer to the instruction manual in order to protect against damage to the product.



Hazardous voltage symbol.



Earth terminal symbol: Used to indicate a circuit common connected to grounded chassis.

Index

Numerics

50% trigger level, 76

A

AC channel coupling, 46, 54
AC trigger coupling, 80, 83
AC trigger sensitivity, 123
accuracy, measurement, 72
acquisition mode, 72
actual sample rate, 67
add math function, 53, 54
aliasing, 56, 62, 75
altitude, 125
ambient temperature, 125
amplitude/div setting, 45
analog bandwidth - maximum frequency check, 135
analog channels, 121
at a glance, 3
attenuation, probe, 50
Auto cursor measurements, 98
automatic calibration, 118
automatic measurement, display, 88
automatic measurements, 88, 124
automatic measurements, clear, 89
automatic measurements, cursors for, 100
automatic measurements, display or hide, 89
automatic time measurements, 93
automatic voltage measurements, 90
Auto-Scale button, 29
Average acquisition mode, 72, 73
averages, 121
averaging acquisition mode, 54

B

band pass filter, 51
band reject filter, 51
bandwidth limit, 48, 122
bandwidth required, oscilloscope, 66
bandwidth, oscilloscope, 63, 120
baud rate, RS-232 interface, 115
beeper sound, 116
Blackman FFT window, 55
brick-wall frequency response, 63
brightness, display, 59

C

calculated rise time, 121
calibration, 118, 129
calibration temperature, 120
calibrator output, 124
channel coupling, 38, 46
characteristics, 121
cleaning the oscilloscope, 148
clear automatic measurements, 89
clear the display, 59
color printing, 109
colors (screen), invert, 60
comma-separated value files, 106
compensate probes, 31
coordinates, grid, 58
counter, frequency, 3, 96
coupling, 122
coupling, trigger, 82
cross-hair cursors, 99
CSV format files, save data to, 106
cursor measurements, 3, 41, 98
Cursors button, 98
cursors for automatic measurements, 100

D

dBVrms scale, 55
DC channel coupling, 46
DC gain accuracy test, 130
DC measurement, 122
DC trigger coupling, 76, 83
DC trigger sensitivity, 123
DC vertical gain accuracy, 120, 122
DC voltage of a level signal, 77
decimating samples, 67, 74
Delay Between Falling Edges measurement, 96
Delay Between Rising Edges measurement, 96
delayed sweep time base, 39, 41
digital filter, 3, 51
display, 124
display all automatic measurements, 89
display brightness, 59, 124
display, clear, 59
distortion, 54
dots waveform type, 58
dynamic range, 55, 122

E

edge speeds, 66
edge trigger, 78, 123
effective sample rate, 43, 70
English language, 115
equipment for performance testing, 128
equipment required, 129
equivalent-time sampling mode, 43, 68, 70
ESD tolerance, 122
EXT trigger level range, 123
EXT/5 trigger level range, 123

Index

external trigger input, 83

F

factory default, 22

Fall Time measurement, 94

FFT (Fast Fourier Transform) math function, 53, 54

FFT resolution, 56

FFT windows, 55

field synchronization, 81

filter, digital, 51

fine scale adjustment, 45

folding frequency, 62

force a trigger, 77

French language, 115

frequency counter, hardware, 3, 96

frequency domain, 54

Frequency measurement, 93

frequency, Nyquist, 62

front panel control, 24

functions, math, 53

G

gate time, frequency counter, 97

Gaussian frequency response, 64

German language, 115

GND channel coupling, 46

grayscale printing, 109

grid, changing, 58

ground reference, 45

ground reference symbol, 46

H

Hanning FFT window, 55

hardware frequency counter, 3, 93, 96, 124

harmonic content, 54

HF reject trigger coupling, 83

HF Reject trigger sensitivity, 123

hide all automatic measurements, 89

high frequency probe compensation, 32

high pass filter, 51

holdoff, trigger, 42, 122

horizontal controls, 36

horizontal failure margin (mask), 114

horizontal position knob, 36, 39, 42

horizontal resolution, 70

horizontal scale, 38, 69

horizontal scale indicators, 37

horizontal scale knob, 36, 38

horizontal time base, 40

horizontal time/div, 74

humidity, 125

I

indoor use, 125

infinite persistence, 59

input capacitance, 122

input resistance, 122

input voltage, 23, 130, 135

input, maximum, 121, 123

installation categories, 125

installed module information, 116

internal storage, 3, 101

internal trigger level range, 123

invert a waveform, 51

invert screen colors, 60

IO parameters, 115

Italian language, 115

J

Japanese language, 115

K

key tests, 117

Korean language, 115

L

language, setting the, 115

LCD display, 3

LF reject trigger coupling, 76, 83

LF reject trigger sensitivity, 123

line frequency, 125

line synchronization, 81

line voltage, 125

Load menu (for USB device), 108

loading data, 102

Local function of Force button, 77

log scale, 55

low frequency probe compensation, 31

low pass filter, 51

M

Main/Delayed button, 36, 39

Manual cursor measurements, 98

manually adjustable cursors, 98

mask test, 41, 112

mask, creating, 114

mask, loading, 114

mask, saving, 114

masks, setting up, 114

math function waveforms, 3, 41, 53

math scale setting, 53

maximum input, 121, 123

maximum sample rate, 67, 121

measurement accuracy, 72

measurements, cursor, 98

memory, 3

memory depth and sample rate, 67

menu buttons, 26

menu display time, 59

Menu On/Off button, 27

menus, 26, 115

model number, 116, 146

modes, horizontal, 122

module information, 116

multiply math function, 53, 54

N

N2862A passive probe, 18

N2863A passive probe, 18

Negative Duty Cycle measurement, 95

Negative Pulse Width measurement, 95

noise in DC power supplies, characterizing, 54

non-repetitive waveforms, 69
 nonvolatile memory locations, 101
 Normal acquisition mode, 72
 normal adjustment, 45
 NTSC standard, 80
 Nyquist frequency, 56
 Nyquist sampling theory, 62

O

offset range, 121
 oscilloscope bandwidth, 63
 oscilloscope bandwidth required, 66
 oscilloscope display, 28
 oscilloscope rise time, 65
 oscilloscope sample rate, 65
 oscilloscope setups, saving and loading, 103, 105
 overshoot measurement, 92

P

package contents, 18
 PAL standard, 80
 parallel cursors, 98
 passive probes, 18
 Peak Detect acquisition mode, 74
 peak detection, 121
 performance test interval, 128
 performance, testing, 128
 Period measurement, 93
 persistence, waveform, 59
 physical size, 124
 playing-back waveforms, 83, 84
 pollution degree, 125
 Portuguese language, 115
 Positive Duty Cycle measurement, 95
 Positive Pulse Width measurement, 95
 potentiometer adjustment, 38
 power cord, 21
 power source, 21
 power supply testing, 38
 power up times, 116
 power usage, 125

preshoot measurement, 92
 printers, supported, 110
 probe attenuation, 50
 probe compensation signal, 23
 programming the oscilloscope, 115
 pulse trigger, 78
 pulse waveforms, 69
 pulse width trigger, 79, 123

R

random noise, 72
 range, horizontal, 122
 range, vertical, 121
 real-time sampling mode, 68, 69
 recalling data, 102, 104
 recorded waveforms, storing, 86
 recording waveforms, 83
 Rectangle FFT window, 55
 reference, 45
 reference waveform, 41, 57
 reference waveform, saving, 57
 refresh rate, 73
 repetitive waveforms, 70
 required oscilloscope bandwidth, 66
 resolution, display, 124
 Rise Time measurement, 94
 rise time, calculated, 121
 rise time, oscilloscope, 65
 rise time, signal, 66
 RS-232 interface baud rate, 115
 Run Control buttons, 33
 Run/Stop button, 33
 Russian language, 115

S

safety
 notices, 2, 147
 symbols, 149
 sample rate and memory depth, 67
 sample rate, maximum, 3
 sample rate, oscilloscope, 43, 63, 65
 sample rate, X-Y format, 41

sampling mode, 68
 sampling theory, 62
 sampling, overview, 62
 save data to CSV format files, 106
 Save menu (for USB device), 106
 save screens to BMP files, 105
 Save/Recall button, 22, 102
 saving data, 102, 104
 screen colors, invert, 60
 screen refresh rate, 73
 screen tests, 117
 screens, saving to BMP files, 105
 SECAM standard, 80
 self-calibration, 118
 self-tests, 117
 sensitivity, trigger, 123
 sequence, 83
 serial number, 116, 146
 setups, saving and loading, 103, 105
 shipping container, 18
 shock, 125
 Simplified Chinese language, 115
 sine(x)/x interpolation, 38, 69
 Single button, 33
 single-shot waveforms, 69
 Slow Scan mode, 38
 software version, 116
 sound, turning on/off, 116
 sources, trigger, 122
 Spanish language, 115
 specifications, 120
 square waves, 64
 status bar, 37
 store recorded waveforms, 86
 subtract math function, 53, 54
 supported printers, 110
 sweep speed, 38
 sweep, trigger, 122
 symbols, safety, 149
 system information, displaying, 116

Index

T

temperature at last calibration, 120
test equipment, 128
testing performance, 128
theory, sampling, 62
time measurements, 3, 41, 93, 98, 124
timebase accuracy, 122
Track cursor measurements, 98
tracking cross-hair cursors, 99
Traditional Chinese language, 115
transducer monitoring, 38
trigger controls, 42
trigger coupling, 82
trigger holdoff, 42
trigger holdoff, reset, 43
trigger level, 76, 97
trigger level range, 123
trigger mode, 78
trigger offset, resetting, 42
trigger position, 37
trigger sweep, 82
trigger system controls, 76
triggering, 3

U

under-sampled signals, 62
untriggered sample acquisition mode, 41
USB device, loading a file from, 108
USB device, saving a file to, 106
USB ports, 3
Utility button, 111

V

Vamp (amplitude voltage = $V_{top} - V_{base}$)
measurement, 91
Vavg (average voltage) measurement, 91
Vbase (base voltage) measurement, 91
vectors, 41
vectors waveform type, 58
vernier adjustment, 45
vertical failure margin (mask), 114
vertical performance verification, 130

vertical position, 46
vertical position knobs, 44, 46
vertical resolution, 121
vertical scale, 45
vertical scale knobs, 44, 45
vertical scaling, 50
vibration, 125
vibration, analyzing, 54
video trigger, 78, 80, 123
Vmax (maximum voltage)
measurement, 91
Vmin (minimum voltage) measurement, 91
voltage measurements, 3, 41, 90, 98, 124
Vpp (peak-to-peak voltage)
measurement, 90
Vrms (root-mean-square voltage)
measurement, 92
Vtop (top voltage) measurement, 91

W

warnings, 147
waveform math, 53
waveform persistence, 59
waveforms, recording/playing-back, 3, 83
waveforms, turning on or off, 45
weight, 124
window, FFT, 55

X

X-Y format, 41
X-Y time base, 40

Y

Y-T time base, 40

www.agilent.com

© Agilent Technologies, Inc. 2005, 2007

Available in electronic format only
Third Edition, December 2007



D3000-97015



Agilent Technologies